

marantz

HORIZON | Luxury Wireless Speaker

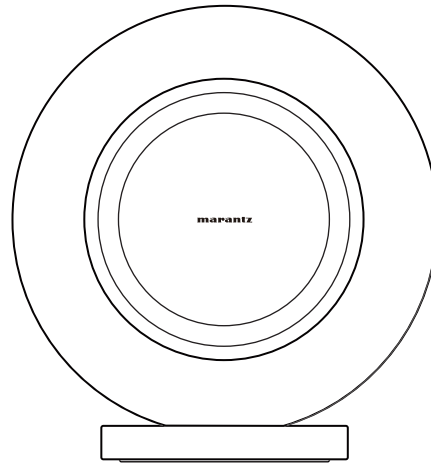

Owner's Manual

Introduction

Accessories	4
Part names and functions	5
Front panel	5
Touch controls	6
Rear panel	7
Connecting	8
Connecting a digital device	8
Connecting an analog device	9
Connecting a USB flash drive	10
Connecting the power cord	11
Attaching the rear cover	12
Getting the HEOS app	13
Setup	
Setting up the HEOS app for the first time with a HEOS Built-in device	14
About HEOS	15
HEOS account	15

Playback

Playing music from a Bluetooth device	16
Using Apple AirPlay	17
Spotify Connect	18
Playing Spotify music with the speaker	18

Troubleshooting

Troubleshooting	19
Cannot connect this unit to the network	20
Cannot pair a Bluetooth mobile device with this unit	20
Cannot hear Bluetooth music	20
Music cuts out or delays sometimes	21
Cannot connect to a network using an iOS device	21
Cannot connect to a WPS network	22
The HDMI control function does not work	22
Audio can be heard coming from the TV speakers	22
I hear a delay when using the external input with my TV	23
Resetting network settings	23
Resetting factory settings	23



LED table

LED table	24
-----------	----

Appendix

Power management	30
Enable/disable Wi-Fi and Bluetooth functions	31
Supported file types and codecs	32
About HDMI	34
Trademark information	35
Specifications	37



Thank you for purchasing this Marantz product.

To ensure proper operation, please read this owner's manual carefully before using the product.

After reading this manual, be sure to keep it for future reference.

Accessories

Check that the following parts are included with the product.

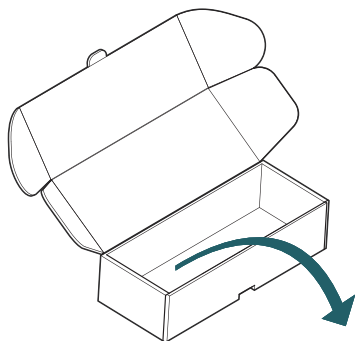

Accessory box



Rear cover

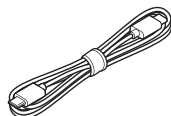

HDMI cable

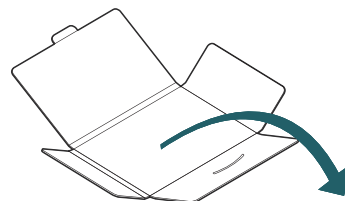

Literature pack



Quick Start Guide



Safety Instructions

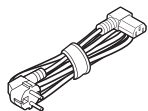

Power cords
(for Europe/UK model)

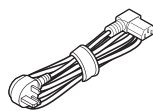

or

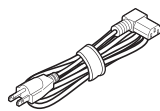

Power cord
(for North America model)



Certificate of Authenticity

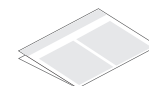

Warranty
(North America model only)



Part names and functions

Front panel

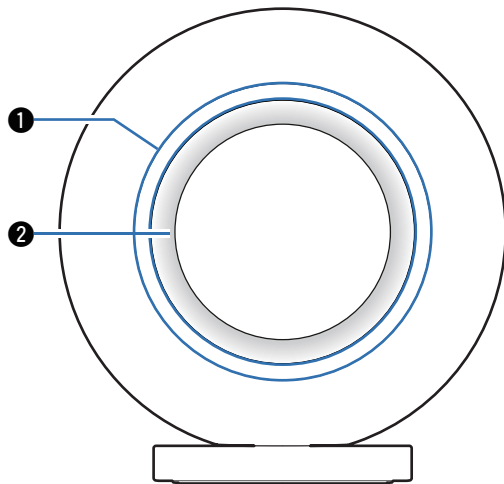

1 Touch ring

Perform playback operations and adjust volume. (☞ p. 6)

2 Front halo light

Please refer to the “LED table” for LED color and state meaning.
(☞ p. 24)



Touch controls

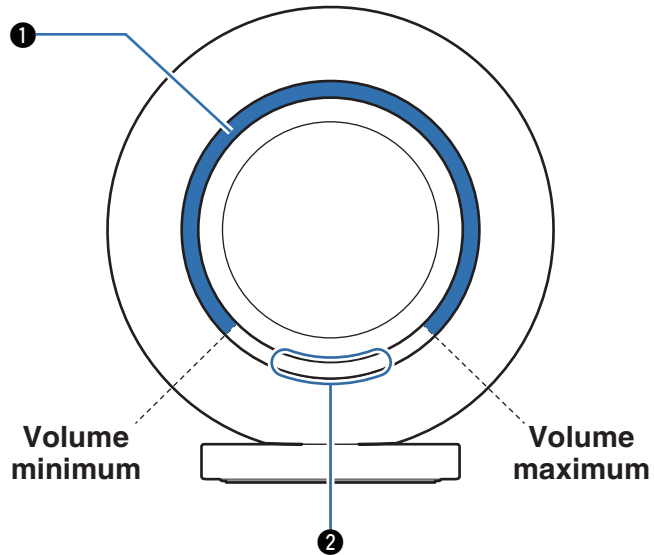

1 Volume control

Touch and hold along the touch ring to increase or decrease the volume according to the position of your finger.

2 Playback controls

Use the bottom of the touch ring to perform playback operations:

Single tap: Play/Pause

Double tap: Skip Forward

Triple tap: Skip Backward



Rear panel

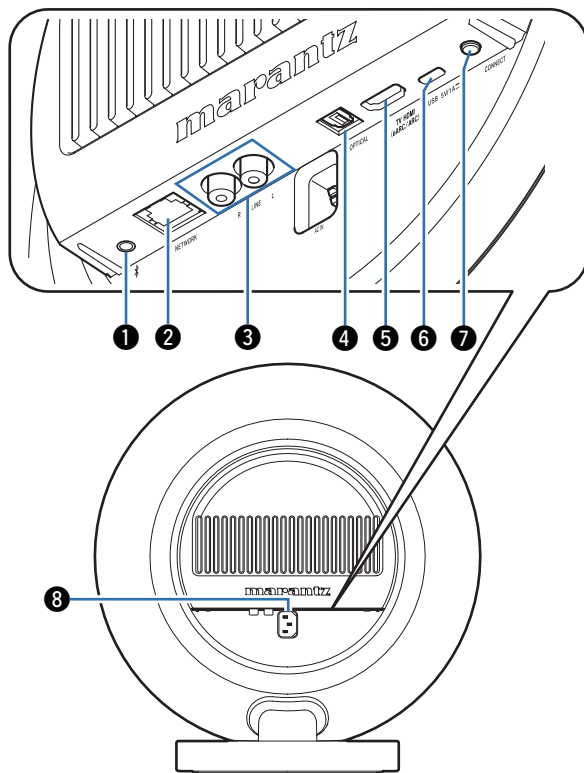

- 1 Bluetooth button** (🔗)

Used to pair the speaker with Bluetooth audio sources. (👉 p. 16)
- 2 NETWORK connector**

Used to connect the speaker to a wired Ethernet network.
- 3 LINE input connectors**

Used to connect analog audio devices to the speaker. (👉 p. 9)
- 4 OPTICAL input connector**

Used to connect digital audio devices to the speaker. (👉 p. 8)
- 5 HDMI connector (eARC)**

Used to connect the speaker to a TV. (👉 p. 8)
- 6 USB (Type C) port**

Used to connect USB (Type C) storage devices (such as USB flash drives). (👉 p. 10)
- 7 CONNECT button**

Used for Wi-Fi setup.
- 8 AC inlet**

Used to connect the power cord. (👉 p. 11)



Connecting

Connecting a digital device

Connect the speaker to a device with an optical digital audio output.

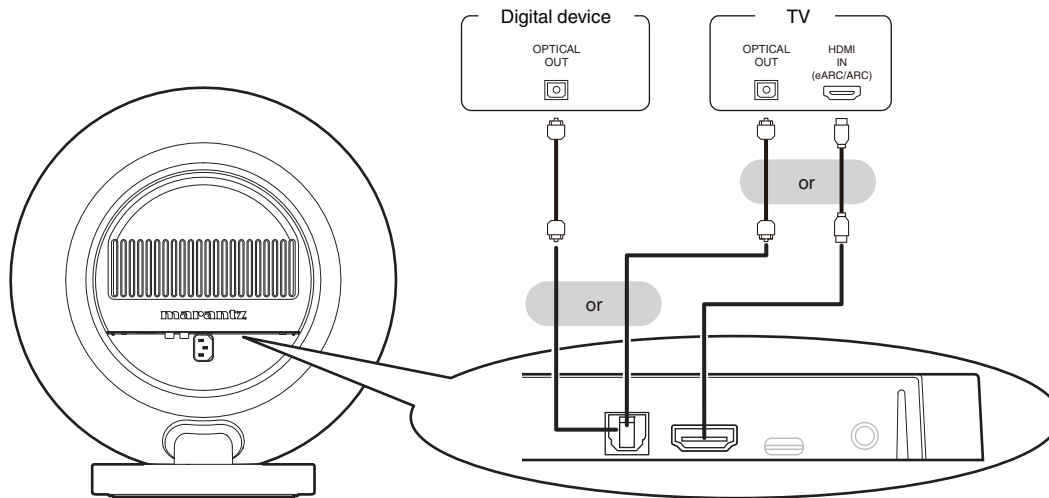

- When connecting a TV to the speaker, turn off the audio output of the TV's internal speakers. See the owner's manual of your TV for details.
- When connecting the HDMI (eARC/ARC) terminal of this speaker to your TV, connect it to the HDMI input terminal of your TV that supports the eARC/ARC function.
- When connecting to a TV that does not support the eARC/ARC function, use an optical connection to play the TV audio.



Connecting an analog device

Connect the LINE input connectors to an audio playback device with analog audio outputs.

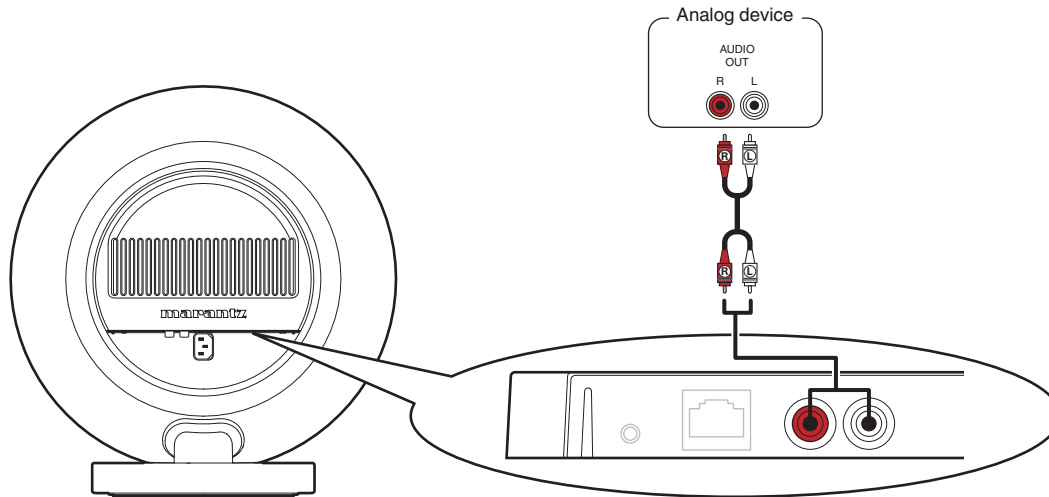

Connecting a USB flash drive

Connect a FAT32 or NTFS formatted USB flash drive containing digital music files to the USB port.

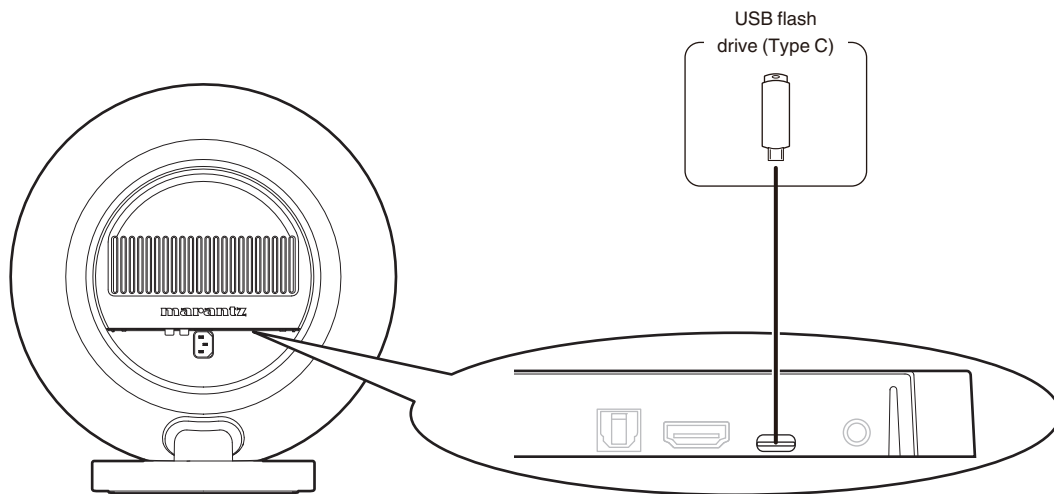

Connecting the power cord

Connect the power cord included in the box between the speaker and an AC outlet.

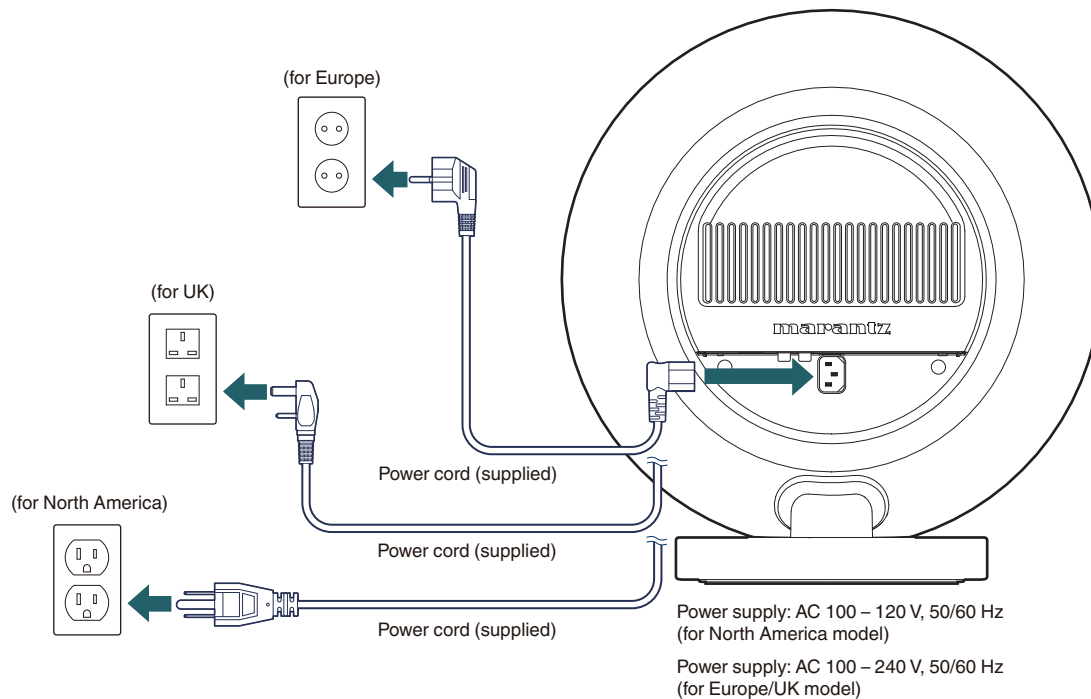

■ Attaching the rear cover

After all connections have been made, attach the included rear cover to this unit.

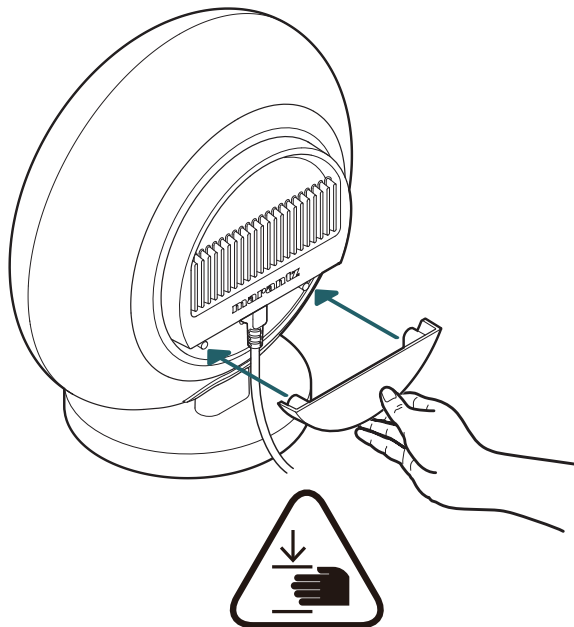

Caution!

- The rear cover is equipped with powerful magnets and may cause injury from pinching between the cover and rear panel. Please attach the rear cover using the hand position shown above.



Getting the HEOS app

Download the HEOS app for iOS or Android by searching App Store®, Google Play™ store or Amazon App Store for “HEOS”.



For the purpose of improvement, the specifications and design of the app are subject to change without notice.



Setting up the HEOS app for the first time with a HEOS Built-in device

Once you have placed the speaker in your listening room and have downloaded the HEOS app, you are ready to configure the speaker for music playback. This involves following a few simple steps to get the speaker connected to your existing home network:



- Do not connect the Ethernet cable if you are connecting this unit to a wireless network. If you are connecting this unit to a wired network, use an Ethernet cable (not included) to connect this unit to your network or router.

1 Make sure your mobile device is connected to your wireless network (the same network you want this unit connected to).

You can check this in the “Settings” - “Wi-Fi” menu of your iOS or Android device.



- Activate the Bluetooth setting on your mobile device.
- If your wireless network is secure, make sure you know the password to join your network.

2 Launch the HEOS app on your mobile device.



3 Tap the “Setup Now” button at the top of the screen.

4 Follow the instructions to add this unit to your wireless network.



- If you have any problems connecting your speaker, jump to the Troubleshooting section ( p. 19).



About HEOS

The HEOS system is a true multiroom audio system that automatically synchronizes audio playback between multiple HEOS Built-in devices so that the audio coming from different rooms is perfectly in sync and always sounds amazing! You can easily add up to 32 HEOS Built-in devices to your HEOS system.

HEOS account

■ What is a HEOS account?

A HEOS account is a master account or “keychain” for managing all of your HEOS music services with one single username and password.

■ Why do I need a HEOS account?

With a HEOS account, you only need to enter your music services login names and passwords once. This allows you to easily and quickly use multiple controller apps on different devices. You just log into your HEOS account on any device and you will have access to all of your associated music services, play history and custom playlists, even if you are at a friend’s house listening to music on their HEOS system.

■ Signing up for a HEOS account

You will be instructed to sign up for a HEOS account the first time you try to access any music service from the “Home” screen of the HEOS app.



Playing music from a Bluetooth device

- 1** Activate the Bluetooth setting on your mobile device.
- 2** Press and hold the Bluetooth button (⌘) located on the rear panel of the speaker for 3 seconds and release the button when you see the front halo light flash.

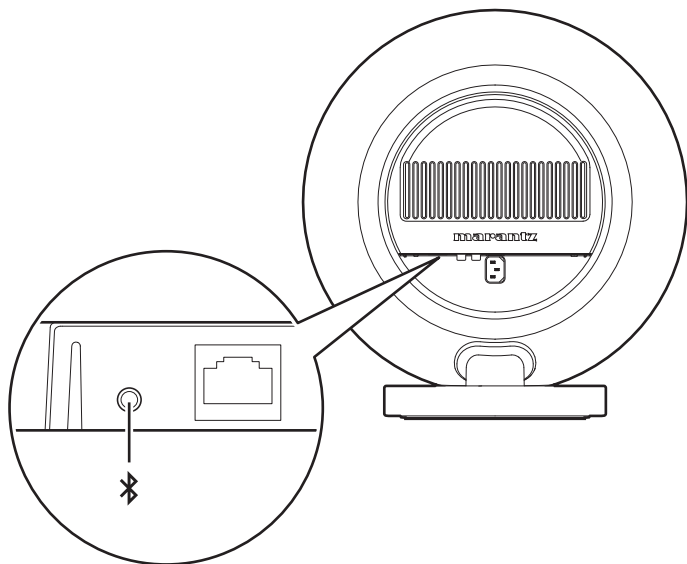

- 3** Select “Marantz Horizon” from the list of available Bluetooth devices.

In a few seconds, your mobile device will indicate that it is connected to this unit.

- 4** Play music using any app on your device.

The sound will now play from this unit.

NOTE

- If no sound is heard, disconnect and reconnect Bluetooth connections from your Bluetooth device.



Using Apple AirPlay

Music files stored on your iPhone, iPod touch, iPad, Mac or Windows PC can be played on this unit via the network.



- Input source will be switched to “AirPlay” when AirPlay playback is started.
- You can stop AirPlay playback by choosing another input source.
- The screen may differ depending on the OS and software versions.

This device supports AirPlay 2®.

Sync multiple AirPlay 2 compatible devices/speakers for simultaneous playback.



Spotify Connect

Spotify is all the music you'll ever need. Millions of songs available instantly. Just search for the music you love, or let Spotify play you something great. Spotify works on your phone, tablet, computer and home speakers. So you'll always have the perfect soundtrack for whatever you're doing. Now you can enjoy Spotify with your free account as well as a Premium account.

Use your phone, tablet or computer as a remote control for Spotify. Go to www.spotify.com/connect to learn how.

The Spotify software is subject to third party licenses found here: www.spotify.com/connect/third-party-licenses

Playing Spotify music with the speaker

Download the "Spotify App" onto your iOS or Android device beforehand.

- 1 Connect the Wi-Fi settings of the iOS or Android device to the same network as the speaker.**
- 2 Launch the Spotify App.**
- 3 Play back a Spotify track.**
- 4 Tap the Spotify icon  to select the unit.**
The music will stream to the speaker.



Troubleshooting

If a problem should arise, first check the following:

1. **Are the connections correct?**
2. **Is this unit being operated as described in the owner's manual?**
3. **Are the other devices operating properly?**



- If the steps above do not improve the problem, restarting the unit may improve the problem. Remove and re-insert the power cord of the unit.

If this unit does not operate properly, check the corresponding symptoms in this section.

If the symptoms do not match any of those described here, consult your dealer as it could be due to a fault in this unit. In this case, disconnect the power immediately and contact the store where you purchased this unit.



Cannot connect this unit to the network

- Make sure your mobile device is connected to your wireless network before setting up this unit. (☞ p. 14)
- Alternatively, you can connect this unit to your network router using an Ethernet cable sold separately. Once connected via Ethernet, the HEOS app should recognize the device and you can manually move it to your wireless network using “Settings” - “My Devices” - (“Device Name”) - “Advanced” - “NETWORK SETTINGS”.

Cannot pair a Bluetooth mobile device with this unit

- The connection from the Bluetooth mobile device is malfunctioning. Power cycle the mobile device, remove the pairing information and re-pair this unit to the mobile device.

Cannot hear Bluetooth music

- Your Bluetooth mobile device is not paired with this unit. Re-pair this unit to the mobile device.
- This unit is in Wi-Fi mode or LINE-in mode, etc. Pair and connect a Bluetooth device to this unit.
- The Bluetooth mobile device is connected to another audio device. Make sure your Bluetooth device is connected to this unit.
- The volume on your Bluetooth mobile device or your speaker is set too low. Check the volume on the Bluetooth mobile device. Check the volume on this unit.



Music cuts out or delays sometimes

- Make sure your Internet connection is operating correctly. If you are sharing your network with other users or devices, they may be using most of your bandwidth (especially if they are streaming video).
- Make sure this unit is within range of your wireless network.
- Make sure this unit is not located near other electronic devices that could interfere with its wireless connectivity (like microwave ovens, cordless phones, TVs, etc.).

Cannot connect to a network using an iOS device

- This speaker supports Apple's WAC (Wireless Accessory Configuration) setup mode. WAC setup mode allows you to connect your speaker to your network without requiring you to type in the network name and password.
The iOS device firmware version needs to support iOS 10.0.2 or later.
 1. On the speaker, press and hold at the top and bottom of the control ring for 3 seconds until the Halo light turns amber.
 2. On your iOS device, go to the Wi-Fi menu under Settings.
 3. Select "Marantz Horizon"] under "SET UP NEW AIRPLAY SPEAKER..." at the bottom of the list.
 4. Select the network you want your speaker to connect to and select "Next".
 5. Follow the instructions on the screen to complete setup.

HEOS system will stay in WAC setup mode for 15 minutes. If the device is not set up within 15 minutes, it will revert back to its previous network connection. Press the bottom touch button if you want to cancel WAC setup mode.

The front halo light will quickly blink 5 times.



Cannot connect to a WPS network

- If your wireless router supports WPS (Wi-Fi Protected Setup™), your speaker can optionally connect to your network using the “Push Button” method by following these steps:
 1. Press the WPS button on your router.
 2. Within 2 minutes, press and hold the CONNECT button on the rear panel of the speaker for 5 seconds.
 3. The front halo light will flash green for several seconds as it connects to your WPS router.
 4. When the connection is complete, the front halo light will turn solid white.

Wi-Fi Protected Setup™ is trademarks of Wi-Fi Alliance.

The HDMI control function does not work

The HDMI control function does not work.

- You cannot operate devices that are not compatible with the HDMI control function. In addition, depending on the connected device or the settings, the HDMI control function may not work. In this case, operate the external device directly.
- Check that the HDMI control function setting is enabled on the TV connected to this unit.

Audio can be heard coming from the TV speakers

Audio can be heard coming from the TV speakers.

- Disable the TV speakers (Some TVs have a dedicated rear-panel switch for this purpose, however on most TVs you must disable the built-in speakers in the setup menu).



I hear a delay when using the external input with my TV

I hear a delay when using the external input with my TV.

- If you are connecting the external input with your cable or satellite box for enjoying TV audio through multiple HEOS built-in devices, you may hear a delay between when you see someone speak and when you hear the audio. This is because the HEOS system must buffer the audio before it sends it out to the HEOS built-in devices, so that it arrives at all devices at the same time. You can avoid this delay by listening only to the device which is directly connected to the set top box.

Resetting network settings

- If network content cannot be played or the unit cannot connect to the network, resetting the network device may improve the problem. Network settings are reset to the factory default values. After restoring the factory default settings, reconfigure the settings appropriately for your network. To network reset this unit, press and hold the CONNECT button located on the rear panel of this unit for 10 seconds until the front halo light begins to flash amber.

Resetting factory settings

- Resetting your speaker will delete the wireless network info, name and all settings but retain its current software. You must use “Settings” - “Add Device” to reconnect the speaker to your home network before it can be used. To reset this unit, press and hold the CONNECT and Bluetooth (📶) buttons located on the rear panel of this unit for 5 seconds until the front halo light begins to flash amber.





LED table

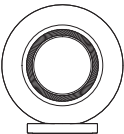
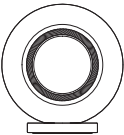
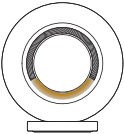

The LEDs on the front panel indicate the current status.

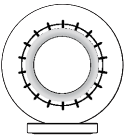
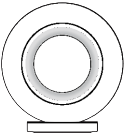
Status	Front Halo light	Description
Power Off (when the main plug is removed)	 off	
Auto Standby	 off	The speaker is in auto standby mode (Connected to your network). (p. 30)
	 dimmed solid amber	The speaker is in auto standby mode (Not connected to your network). (p. 30)



Status	Front Halo light	Description
Powering on	 blinking white	The speaker is starting up or connecting to the network.
	 solid white	The speaker is connected to the network.
	 solid amber	The speaker is unable to connect to the network. Try to connect this unit again.

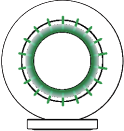
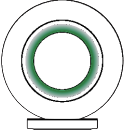

Status	Front Halo light	Description
WPS	 blinking green	The speaker is connecting to the network via WPS.
	 solid green for 3 seconds	The speaker is connected to the network via WPS.
	 solid red for 3 seconds	WPS has timed out.

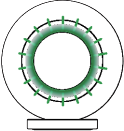
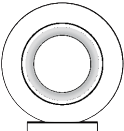
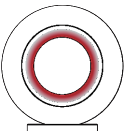

Status	Front Halo light	Description
Bluetooth	 blinks green twice	The speaker is pairing via Bluetooth.
	 solid white	The speaker is paired via Bluetooth.
	 solid red for 3 seconds	The speaker failed to pair to the Bluetooth device. Try to pair again. (☞ p. 16)

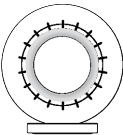
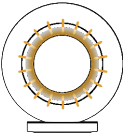
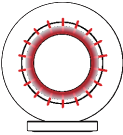

Status	Front Halo light	Description
Volume setting	 blinking white slowly	The speaker is muted.
Firmware update	 blinking amber	Firmware is being updated.
	 blinking red slowly (not fading)	There is a firmware error. Check your Internet connection quality, relaunch the app, then try to update the firmware again.

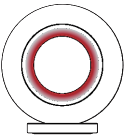
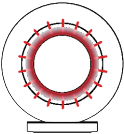
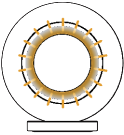
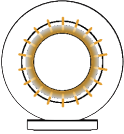

Status	Front Halo light	Description
Error	 <p data-bbox="576 322 659 342">solid red</p>	<p data-bbox="802 217 1481 292">There was a setup error. Check your usage environment, then follow the correct procedure to try setup again. If the error occurs again, restore factory settings and try setup again. (☰ p. 23)</p>
	 <p data-bbox="528 512 707 533">blinking red rapidly</p>	<p data-bbox="802 418 1497 468">There is a hardware error. Unplug the power cord, wait about 30 seconds, then plug the power cord back in.</p>
Factory reset	 <p data-bbox="512 703 722 723">blinking amber rapidly</p>	<p data-bbox="802 620 1145 640">Factory settings have been restored.</p>
Network reset	 <p data-bbox="512 893 722 913">blinking amber rapidly</p>	<p data-bbox="802 810 1121 831">Network settings have been reset.</p>



Power management

■ Auto Standby

The speaker automatically enters standby mode to save power after 20 minutes of inactivity including:

❑ Ethernet

After 20 minutes of no operation and no network access after playing music via Ethernet.

❑ Wi-Fi

After 20 minutes of no operation and no network access after playing music via Wi-Fi.

❑ USB

After 20 minutes of no operation and no network access after playing music from a USB flash drive.

❑ Bluetooth

After the Bluetooth connection is disconnected and there is 20 minutes of no operation and no network access after playing music via Bluetooth.

❑ LINE input

After 20 minutes of no audio.

❑ Optical input

After 20 minutes of no operation after optical device is put into standby.

❑ HDMI (eARC/ARC)

Connect this unit and the eARC/ARC compatible TV with HDMI cable and play TV. 20 minutes after TV is put into standby.

■ Off

To completely turn off the power to the device, you must remove the mains plug from the power outlet.



Enable/disable Wi-Fi and Bluetooth functions

By disabling Wi-Fi and Bluetooth functions, you can reduce power consumption in Auto Standby. Follow these steps to disable/enable these functions:

- 1** In the HEOS app, tap the “Home” tab.
- 2** Select the Settings  icon in the upper-right corner of the screen.
- 3** Select “My Devices”.
- 4** Select “Marantz Horizon”.
- 5** Select “Network”.

■ Wi-Fi

On
(Default): Wi-Fi function enabled.

Off: Wi-Fi function disabled.



- When setting Wi-Fi to “Off”, use an Ethernet cable to establish the network connection.

■ Bluetooth

On
(Default): Bluetooth function enabled.

Off: Bluetooth function disabled.



Supported file types and codecs

Sampling frequency	Bit length	File extension	Codec	Bit rates
32/44.1/48/88.2/96/176.4/192 kHz	16/24 bit	wav	PCM	–
32/44.1/48 kHz	16 bit	mp3	MPEG-1 Audio Layer 3 CBR/VBR	32 - 320 kbps
32/44.1/48 kHz	16 bit	m4a aac	AAC-LC	48 - 320 kbps
32/44.1/48 kHz	16 bit	wma	wma9 CBR	CBR:48 - 192 kbps
44.1/48/88.2/96/176.4/192 kHz	16/24 bit	flac	flac	–
44.1/48/88.2/96/176.4/192 kHz	16/24 bit	m4a	ALAC	–
2.8/5.6 MHz	1 bit	dff dsf	DSDIFF DSF	–

NOTE

- For USB flash drive, the limited numbers of folders and files that can be played back on this unit are as follows.
 - Number of folder directory levels: 8 levels (The limited number includes the root folder.)
 - Number of folders: 500
 - Number of files: 5000 (The allowable number of files may differ according to the USB flash drive capacity and the file size.)
- Files protected by DRM, such as Apple's Fairplay DRM, are not supported.
- If you select a music source with a high bit rate or high resolution, it is set to the appropriate level by codec before being output.
- The ALAC decoder is distributed under the Apache License, Version 2.0 (<http://www.apache.org/licenses/LICENSE-2.0>)



■ Supported audio formats (Optical)

2-channel Linear PCM	2-channel, 32 kHz – 192 kHz
Bitstream	Dolby Digital

■ Supported audio formats (HDMI)

2-channel Linear PCM	2-channel, 32 kHz – 192 kHz
Multi-channel Linear PCM	7.1-channel, 32 kHz – 192 kHz
Bitstream	Dolby Digital / Dolby Atmos / Dolby TrueHD / Dolby Digital Plus



About HDMI

This unit supports the following HDMI functions.

- **eARC (Enhanced Audio Return Channel)/ARC (Audio Return Channel) function**

Enjoy movies, music, etc., on your TV simply by connecting an eARC/ARC function-compatible TV to this unit via HDMI.

- **HDMI control function**

Connect an HDMI control-compatible TV and this unit via HDMI and enable the HDMI control to enable linked control from either device.

- **Input source switching**

If the TV is turned on, this unit automatically powers on and switches the input source.

- **Power off link**

The TV power off operation is linked so this unit also turns off.

- **Volume adjustment**

The volume of this unit can be adjusted using the TV remote control.

- **Audio output destination switching**

If this unit is turned on, TV audio is output from this unit. If this unit is turned off, TV audio is output from the speakers of the TV.



- Some functions may not operate depending on the connected TV.



Trademark information



Apple, AirPlay, iPad, iPad Air, iPad Pro, iPhone and Mac are trademarks of Apple Inc., registered in the U.S. and other countries.

The trademark "iPhone" is used in Japan with a license from Aiphone K.K.

Use of the Works with Apple badge means that an accessory has been designed to work specifically with the technology identified in the badge and has been certified by the developer to meet Apple performance standards.



The Bluetooth® word mark and logos are registered trademarks owned by the Bluetooth SIG, Inc. and any use of such marks by DEI Sales, Inc. is under license. Other trademarks and trade names are those of their respective owners.



Dolby, Dolby Atmos, and the double-D symbol are registered trademarks of Dolby Laboratories Licensing Corporation. Manufactured under license from Dolby Laboratories. Confidential unpublished works. Copyright © 2012–2024 Dolby Laboratories. All rights reserved.



The terms HDMI, HDMI High-Definition Multimedia Interface, HDMI trade dress and the HDMI Logos are trademarks or registered trademarks of HDMI Licensing Administrator, Inc.





The Wi-Fi CERTIFIED logo is a registered trademark of the Wi-Fi Alliance.

Wi-Fi Certification provides assurance that the device has passed the interoperability test conducted by the Wi-Fi Alliance, a group that certifies interoperability among wireless LAN devices.



Google Play and the Google Play logo are trademarks of Google LLC.



App Store® is registered trademark of Apple, Inc. in the U.S. and other countries.



Specifications

Wireless LAN

Network type:	Conforming to IEEE 802.11a/b/g/n/ac/ax
Used frequency range:	2.4 GHz, 5 GHz, 6 GHz

Bluetooth section

Communications system:	Bluetooth Version 5.4
Transmission power:	Power Class 1
Maximum communication range:	Approx. 98.4 ft/30 m in line of sight *
Used frequency range:	2.4 GHz band
Modulation scheme:	FHSS (Frequency-Hopping Spread Spectrum)
Supported profiles:	A2DP, AVRCP
Corresponding codec:	SBC
Transmission range (A2DP):	20 Hz – 20,000 Hz

* The actual communication range varies depending on the influence of such factors as obstructions between devices, electromagnetic waves from microwave ovens, static electricity, cordless phones, reception sensitivity, antenna performance, operating system, application software, etc.



General

Operating temperature:

41 °F - 95 °F (5 °C - 35 °C)

Power supply:

AC 100 – 240 V, 50/60 Hz (for Europe model)

AC 100 – 120 V, 50/60 Hz (for North America model)

Power consumption:

120 W

Power consumption in Auto Standby:

Connection	Setting items in the HEOS app		Power consumption
	Wi-Fi (🔌 p. 31)	Bluetooth (🔌 p. 31)	
Wi-Fi 2.4 GHz	On	Off	1.8 W
Wi-Fi 5 GHz	On	Off	1.8 W
Ethernet	Off	Off	1.9 W
USB with Ethernet	Off	Off	2.0 W
Bluetooth	Off	On	1.7 W
All with Ethernet	On	On	2.0 W

Max Analog Input:

2 Vrms



Dimensions

Unit : in. (mm)

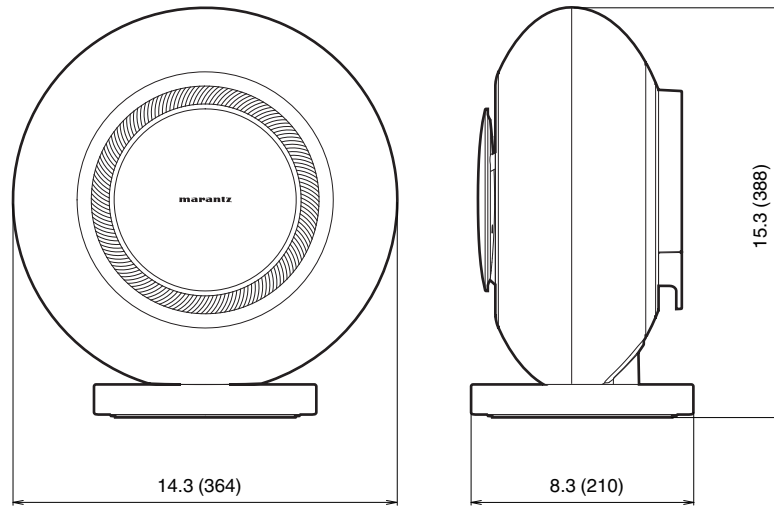

Weight : 27.5 lbs (12.5 kg)

For the purpose of improvement, the specifications and design are subject to change without notice.



marantz

3520 10976 00AS

©2024 Masimo. All Rights Reserved.