

marantz

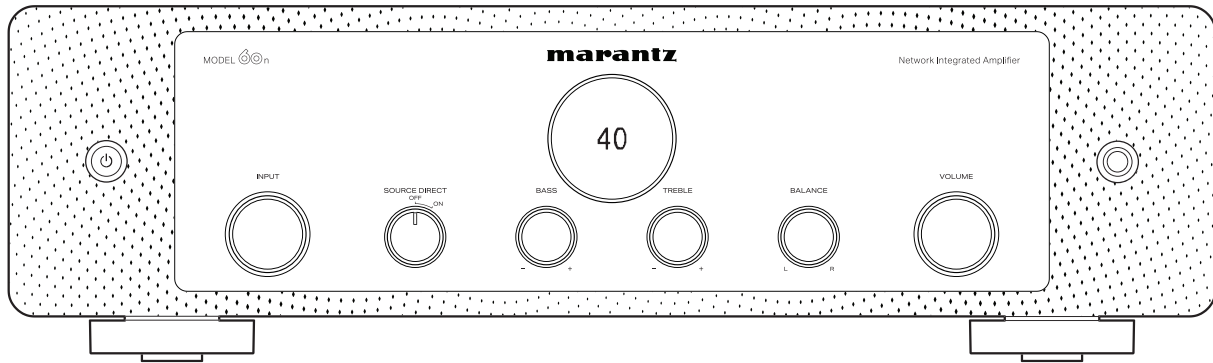

MODEL 60n | Network Integrated Amplifier

Owner's Manual

Accessories	6
Inserting the batteries	7
Operating range of the remote control unit	7
Part names and functions	8
Front panel	8
Rear panel	10
Remote control unit	13

Connections

Connecting speakers	19
Connecting the speaker cables	19
Connecting speakers	20
Connecting the subwoofer	21
Connecting a playback device	22
Connecting to a device with digital audio connectors	23
Connecting a USB flash drive to the USB port	25
Connecting to a home network (LAN)	26
Wired LAN	26
Wireless LAN	27
Connecting a power amplifier	28
Connecting devices with remote control connectors	29
Performing operations by RC on this unit without visual contact	29
Remotely connecting Marantz audio devices	29
Connecting the power cord	31



Playback

Basic operation	33
Turning the power on	33
Switching the power to standby	33
Selecting the input source	34
Adjusting the volume	34
Turning off the sound temporarily (Muting)	34
Playing CDs	35
Listening to music on a Bluetooth device	36
Listening to music on a Bluetooth device	37
Pairing with other Bluetooth devices	38
Reconnecting to this unit from a Bluetooth device	38
Listening to audio on Bluetooth headphones	39
Listening to audio on Bluetooth headphones	40
Reconnecting to a Bluetooth headphones	41
Disconnecting Bluetooth headphones	41
Playing digital input	42
Getting the HEOS app	44
Setting up the HEOS app for the first time with a HEOS built-in device	45
Adding the registration of HEOS built-in devices in the HEOS app	46
HEOS Account	47
Playing from streaming music services	48
Listening to the same music in multiple rooms	50

Listening to Internet Radio	54
Playing music stored on your mobile	54
Playing back files stored on a PC or NAS	55
Playing music from a USB flash drive	55
AirPlay function	57
Playing songs from your iPhone, iPod touch, iPad or Mac	58
Playing songs from Windows PC	58
Play a song from your iPhone, iPod touch, iPad or Mac on multiple synced devices (AirPlay 2)	59
Spotify Connect function	60
Playing Spotify music with this unit	60
Convenience functions	61
Adjusting the tone and balance	61
Playback in source direct mode	61
Playing back HEOS Favorites	62
Switching the display's brightness	62
Using the sleep timer	63



Settings

Menu map	64
Menu operation	66
Audio	67
Lock Range	67
Volume Limit	67
TV	68
TV Input	68
Auto-Play	68
HDMI Power Off Control	68
General	69
Auto-Standby	69
Reset	69
Network	70
Network & USB-A	70
Wi-Fi	70
Bluetooth	71
Network Control	72
AirPlay Setup	72
Connecting by using the WPS button on the router	73

Tips

Tips	75
Troubleshooting	77
Power does not turn on / Power is turned off	78
Operations cannot be performed through the remote control unit	80
Display on this unit shows nothing	80
No sound comes out	81
Sound is interrupted or noise occurs	82
Desired sound does not come out	84
AirPlay cannot be played back	85
USB flash drives cannot be played back	86
Bluetooth cannot be played back	87
The Internet radio cannot be played back	90
Music files on PC or NAS cannot be played back (Music server)	91
Various online services cannot be played	92
Cannot connect to a wireless LAN network	92
Audio from digital devices cannot be played back (HDMI ARC/ Coaxial/Optical)	94
The input source switches to "HDMI", "Optical" or "Coaxial"	94
The HDMI control function does not work	94
Update/upgrade error messages	95
Factory Restore	96



Appendix

Playing back a USB flash drives	97
Digital input	98
Playing back a Bluetooth device	99
Playing back files stored on a PC and NAS	100
Playing back Internet Radio	101
Last function memory	101
About HDMI	102
Explanation of terms	103
Trademark information	107
Specifications	109
Index	114





Thank you for purchasing this Marantz product.

To ensure proper operation, please read this owner's manual carefully before using the product.

After reading this manual, be sure to keep it for future reference.

Accessories

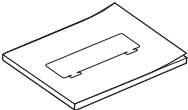
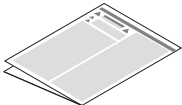
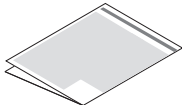
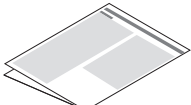
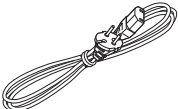
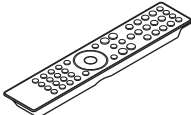
Check that the following parts are supplied with the product.

 Quick Start Guide	 Safety Instructions	 Cautions on Using Batteries	 Notes on radio
 Power cord	 Remote control unit (RC006PM)	 2× R03/AAA batteries	 External antennas for Bluetooth/wireless connectivity



Inserting the batteries

- 1 Remove the rear lid in the direction of the arrow and remove it.



- 2 Insert two batteries correctly into the battery compartment as indicated.

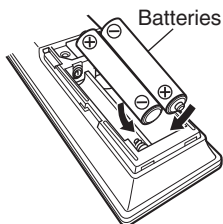

- 3 Put the rear lid back on.

NOTE

- To prevent damage or leakage of battery fluid:
 - Do not use a new battery together with an old one.
 - Do not use two different types of batteries.
- Remove the batteries from the remote control unit if it will not be in use for long periods.
- If the battery fluid should leak, carefully wipe the fluid off the inside of the battery compartment and insert new batteries.

Operating range of the remote control unit

Point the remote control unit at the remote sensor when operating it.

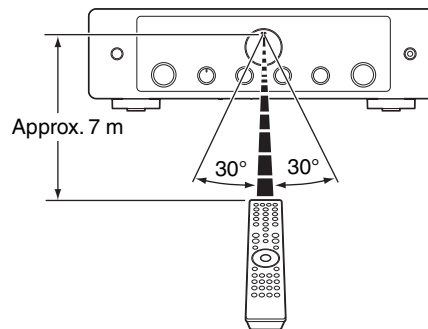

Part names and functions

Front panel

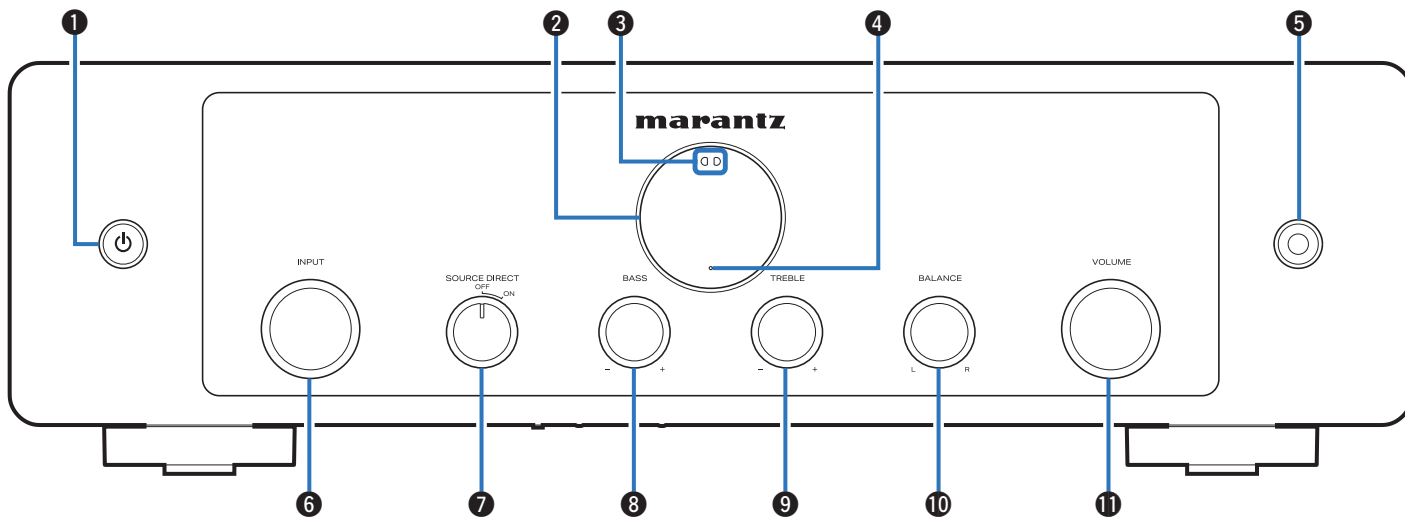

For details, see the next page.



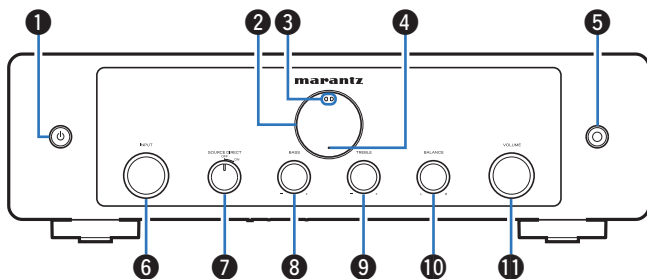

1 Power (⏻) button

This turns the power on/off (standby). (👉 p. 33)

2 Display

This displays various pieces of information.

3 Remote control sensor

This receives signals from the remote control unit. (👉 p. 7)

4 Protection circuit indicator

This blinks when the protection circuit has operated. (👉 p. 78)

5 Headphones jack

Used to connect headphones.

When the headphones are plugged into this jack, audio will no longer be output from the connected speakers and from the PREAMP OUT connectors.

NOTE

- To prevent hearing loss, do not raise the volume level excessively when using headphones.

6 INPUT selector knob

This switches input sources. (👉 p. 34)

7 SOURCE DIRECT switching knob

This turns source direct mode on/off. (👉 p. 61)

8 BASS control knob

This setting adjusts the volume level for the bass. (👉 p. 61)

9 TREBLE control knob

This setting adjusts the volume level for the treble. (👉 p. 61)

10 BALANCE control knob

This adjusts the balance of the volume output from the left and right speakers. (👉 p. 61)

11 VOLUME knob

Adjusts the volume. (👉 p. 34)



- 8, 9 and 10 can be adjusted when 7 is off (Source direct mode is off). (👉 p. 61)



Rear panel

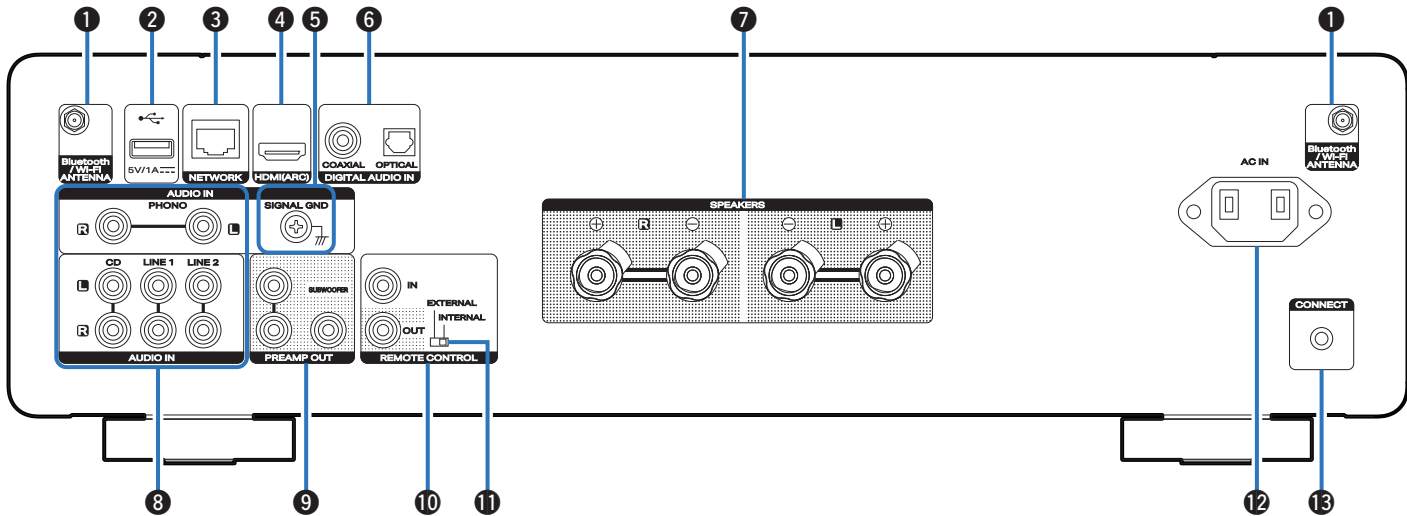

For details, see the next page.



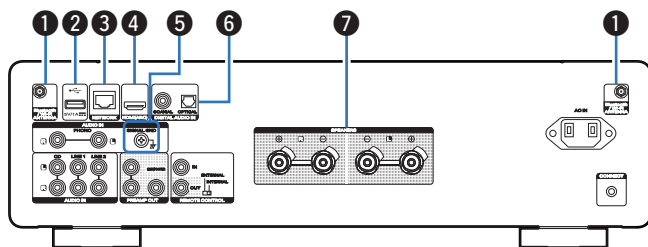

1 Bluetooth/wireless LAN antenna connectors

Used to connect the included external antennas for Bluetooth/wireless connectivity when connecting to a network via wireless LAN, or when connecting to a handheld device via Bluetooth. (☞ p. 27)

- ① Place the external antennas for Bluetooth/wireless connectivity evenly over the screw terminal of rear.
- ② Turn clockwise until the antennas is fully connected.
- ③ Rotate the antenna upwards for best reception.

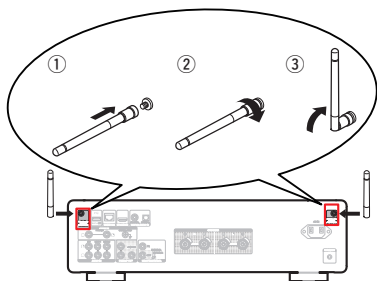

2 USB port (🔌)

This is used to connect USB storages (such as USB flash drives). (☞ p. 25)

3 NETWORK connector

Used to connect to a LAN cable when connecting to a wired LAN network. (☞ p. 26)

4 HDMI connector (HDMI (ARC))

Used to connect an ARC function-compatible TV. (☞ p. 23)

5 SIGNAL GND terminal

Used to connect a ground wire for the turntable. (☞ p. 22)

6 DIGITAL AUDIO IN connectors

Used to connect devices equipped with digital audio output connectors. (☞ p. 23)

7 Speaker terminals (SPEAKERS)

Used to connect speakers. (☞ p. 19)



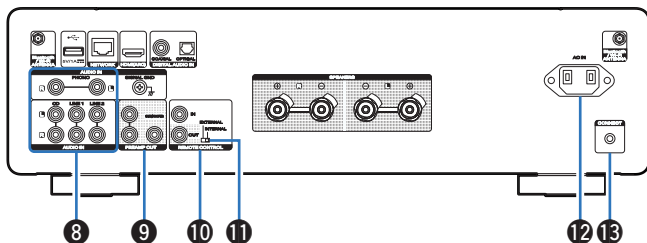

8 AUDIO IN connectors

Used to connect devices equipped with analog audio output connectors.

- “Connecting a playback device” (☞ p. 22)

9 PREAMP OUT connector

- Used to connect a subwoofer with a built-in amplifier. (☞ p. 21)
- Used to connect a power amplifier when this unit is used as a pre-amplifier. (☞ p. 28)

10 REMOTE CONTROL connectors

Used to connect to a Marantz audio device that is compatible with the remote control function. (☞ p. 29)

11 EXTERNAL/INTERNAL switch

Turn this switch to “INTERNAL” to operate the unit by pointing the remote control at this unit connected to a Marantz audio device using the remote control connection. (☞ p. 29)

12 AC inlet (AC IN)

Used to connect the power cord. (☞ p. 31)

13 CONNECT button

Used for Wi-Fi setup. (☞ p. 73)



Remote control unit

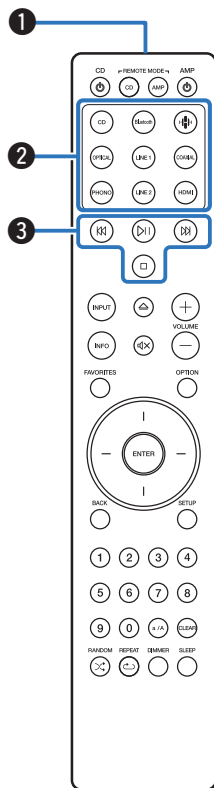

The remote control provided with this unit can control a Marantz CD player.

- “CD player operations” (👉 p. 16)

■ Operating this unit

To operate this unit, press REMOTE MODE AMP button to switch the remote control operating mode to this unit.

1 Remote control signal transmitter

This transmits signals from the remote control unit. (👉 p. 7)

2 Input source select buttons

These select the input source. (👉 p. 34)

3 System buttons

These perform playback related operations.

- Play/Pause button (⏮)
 - Press this button to pause during playback. If pressed while paused or stopped, resumes playback from the last track played.
- Forward-skip button (⏭)
 - Press this button during playback to play the next track.
- Reverse-skip button (⏮)
 - Press this button during playback to restart the current track or play the previous track.
- Stop button (⏹)
 - Press this button to stop during playback.



- Depending on the input source and online service, the operation cannot be performed.



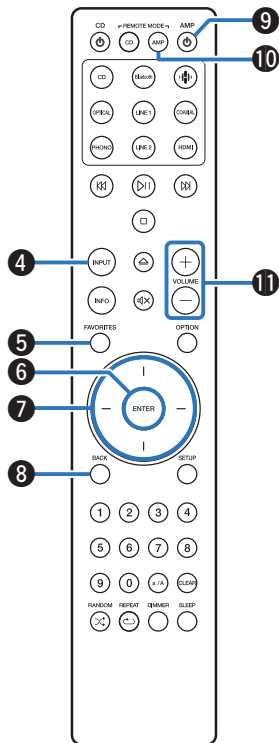

4 Input source select button (INPUT)

This switches input sources. (👉 p. 34)

5 FAVORITES button

This calls up content registered in “HEOS Favorites” using the HEOS app. (👉 p. 62)

6 ENTER button

This determines the selection.

7 Cursor buttons

These select items.

8 BACK button

Returns to the previous item.

9 Power (AMP) button

This turns the power on/off (standby). (👉 p. 33)

10 Remote mode select button (REMOTE MODE AMP)

Switches the remote control operating mode to this unit.

11 VOLUME buttons (+/-)

These adjust the volume level. (👉 p. 34)



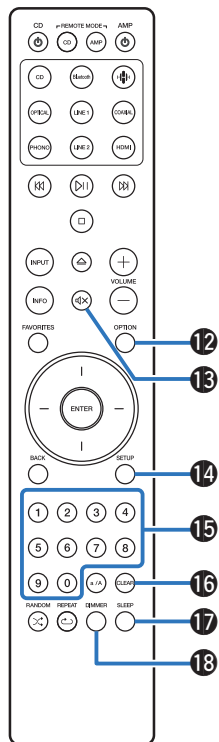

12 OPTION button

This deletes registered Bluetooth devices from the “Devices” list. (👉 p. 71)

13 Mute button (🔇)

This mutes the output audio. (👉 p. 34)

14 SETUP button

The setting menu is displayed on the display. (👉 p. 66)

15 Number buttons (0 – 9)

Input the number of HEOS Favorites. (👉 p. 62)

16 CLEAR button

This cancels the number input.

17 SLEEP button

This sets the sleep timer. (👉 p. 63)

18 DIMMER button

Adjust the display brightness of this unit. (👉 p. 62)



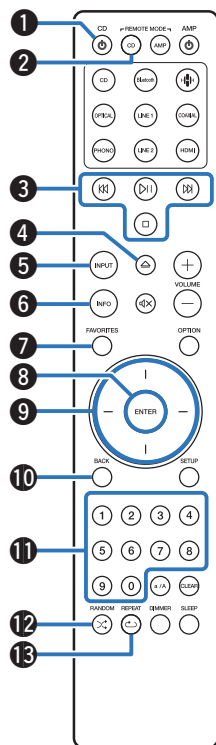

■ CD player operations

A Marantz CD player can be operated.

To operate CD player, press REMOTE MODE CD button to switch the remote control to the CD player operation mode.

- ❶ Power (CD) button
- ❷ Remote mode select button (REMOTE MODE CD)
- ❸ System buttons
- ❹ Disc tray open/close button (\triangle)
- ❺ Input source select button (INPUT)
- ❻ Information button (INFO)
- ❼ FAVORITES button
- ❽ ENTER button
- ❾ Cursor buttons
- ❿ BACK button
- ⓫ Number buttons (0 – 9)
- ⓬ RANDOM button (\times)
- ⓭ REPEAT button (\curvearrowright)



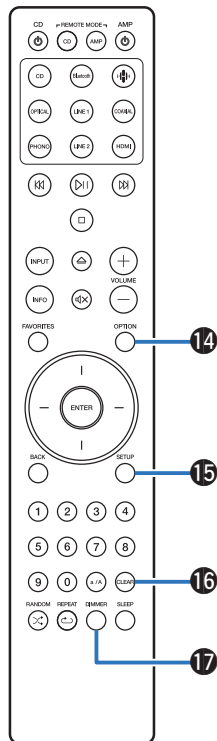

14 **OPTION** button

15 **SETUP** button

16 **CLEAR** button

17 **DIMMER** button



- The remote control may not operate some products.
- 7 **FAVORITES** button functions as a **PROGRAM** button. For details on the **PROGRAM** button, see the owner's manual of the CD player.



■ Contents









Connecting speakers	19
Connecting a playback device	22
Connecting to a device with digital audio connectors	23
Connecting a USB flash drive to the USB port	25
Connecting to a home network (LAN)	26
Connecting a power amplifier	28
Connecting devices with remote control connectors	29
Connecting the power cord	31

NOTE

- Do not plug in the power cord until all connections have been completed.
- Do not bundle power cords with connection cables. Doing so can result in humming or noise.

■ Cables used for connections

Provide necessary cables according to the devices you want to connect.

Speaker cable	
Subwoofer cable	
HDMI cable	
Optical cable	
Coaxial digital cable	
Audio cable	
LAN cable	
Remote connector cable	



Connecting speakers

NOTE

- Disconnect this unit's power plug from the power outlet before connecting the speakers. Also, turn off the subwoofer.
- Connect so that the speaker cable core wires do not protrude from the speaker terminal. The protection circuit may be activated if the core wires touch the rear panel or if the + and - sides touch each other. "Protection circuit" (☞ p. 106)
- Never touch the speaker terminals while the power cord is connected. Doing so could result in electric shock.
- Use speakers with an impedance of 4 – 16 Ω /ohms.

Connecting the speaker cables

Carefully check the left (L) and right (R) channels and + (red) and - (white) polarities on the speakers being connected to this unit, and be sure to connect the channels and polarities correctly.

- 1** Peel off about 10 mm of sheathing from the tip of the speaker cable, then either twist the core wire tightly or terminate it.



- 2** Turn the speaker terminal counterclockwise to loosen it.



- 3** Insert the speaker cable's core wire to the hilt into the speaker terminal.

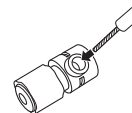

4 Turn the speaker terminal clockwise to tighten it.

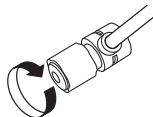

Spade lug connector



Connecting speakers

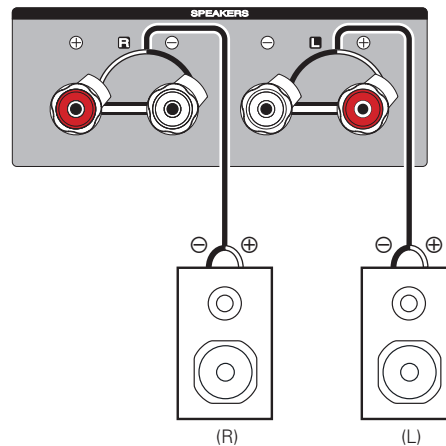

Connecting the subwoofer

Use a subwoofer cable to connect the subwoofer.

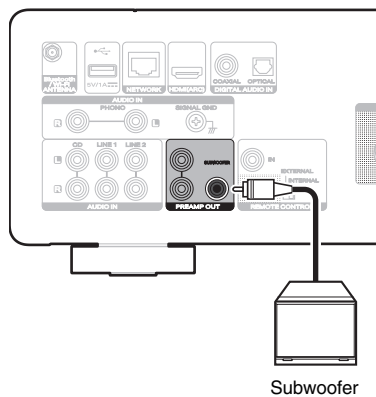

Connecting a playback device

You can connect turntables, tuners, Blu-ray disc players and CD players to this unit.

This unit is compatible with turntables equipped with a moving magnet (MM) phono cartridge. When you connect this unit to a turntable with a low output moving coil (MC) cartridge, use a commercially available MC head amp or a step-up transformer.

If you set this unit's input source to "PHONO" and accidentally increase the volume without connecting a turntable, you may hear a humming noise from the speakers.

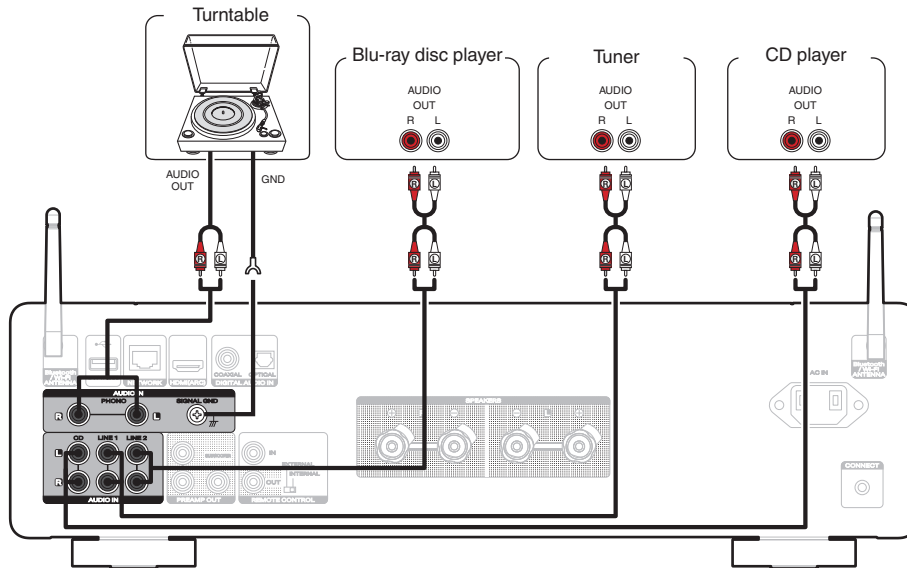

NOTE

- The earth terminal (SIGNAL GND) of this unit is not for safety grounding purposes. If this terminal is connected when there is a lot of noise, the noise can be reduced. Note that depending on the turntable, connecting the ground line may have the reverse effect of increasing noise. In this case, it is not necessary to connect the ground line.



- The PHONO input terminals are equipped with a short pinplug. Remove this plug to connect a record player. Store the removed short pin-plug in a safe place so as not to lose it.



Connecting to a device with digital audio connectors

Use this connection to input digital audio signals to this unit, and convert the signals for playback using the D/A converter of this unit. (☞ p. 42)

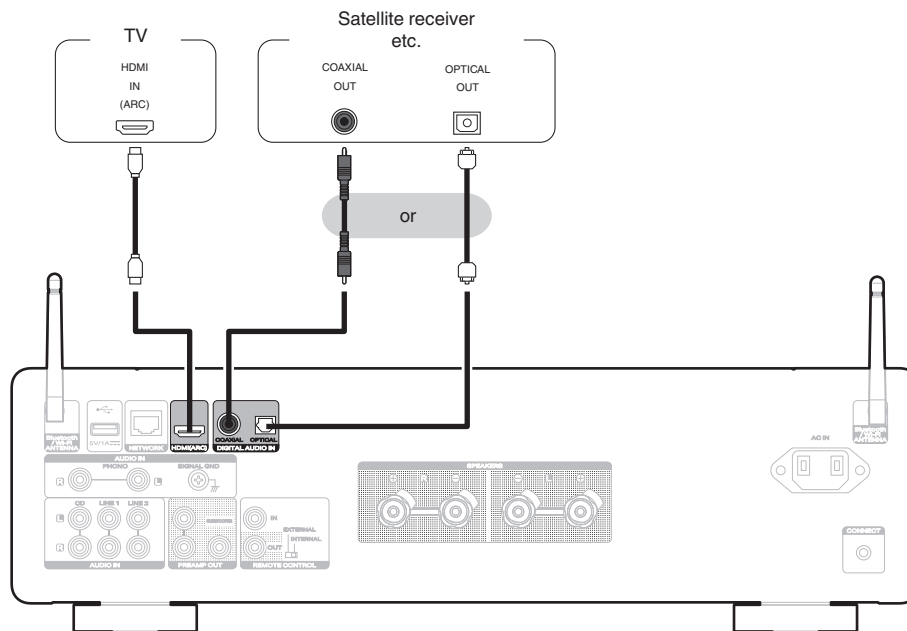



- When connecting a TV to this unit, turn off the audio output of the TV's internal speakers. See the owner's manual of your TV for details.
- When connecting the HDMI (ARC) terminal of this device to your TV, connect it to the HDMI input terminal of your TV that supports the ARC function.
- When connecting to a TV that does not support the ARC function or a TV that does not have an HDMI terminal, use an Optical connection or a Coaxial connection to play the TV audio.

NOTE

- Linear PCM signals with a sampling frequency of 32 kHz, 44.1 kHz, 48 kHz, 88.2 kHz, 96 kHz, 176.4 kHz, or 192 kHz can be input into this unit.
- Do not input non-PCM signals, such as Dolby Digital, DTS and AAC. This causes noise and could damage the speakers.
- Only the PCM 2-channel setting can be used to play sound from a TV via the HDMI ARC function. Set "PCM 2ch" as the audio format in the TV settings.

■ Specifications of supported audio formats

See "Digital input" (🔍 p. 98).



Connecting a USB flash drive to the USB port

For operating instructions see “Playing music from a USB flash drive” (👉 p. 55).

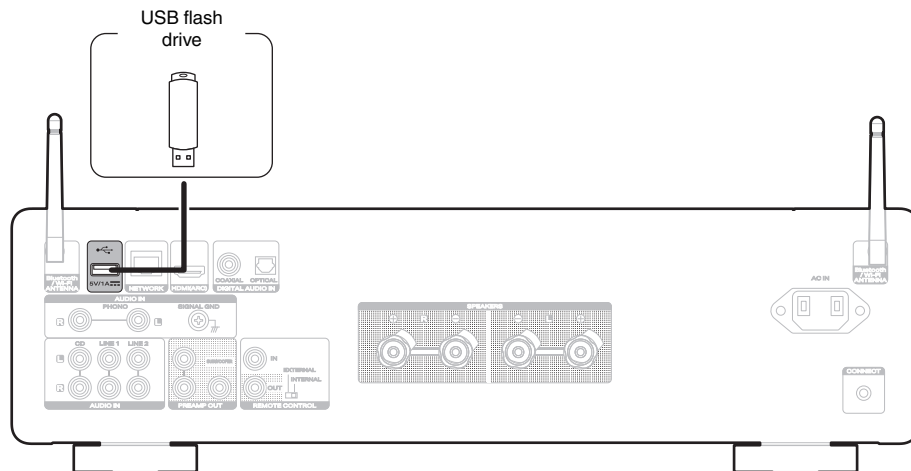

- Marantz does not guarantee that all USB flash drives will operate or receive power. When using a portable USB hard disk drive (HDD) which came with an AC adapter, use that device's supplied AC adapter.

NOTE

- USB flash drives will not work via a USB hub.
- It is not possible to use this unit by connecting the unit's USB port to a PC via a USB cable.
- Do not use an extension cable when connecting a USB flash drive. This may cause radio interference with other devices.



Connecting to a home network (LAN)

This unit can connect to a network using a wired LAN or wireless LAN. You can connect this unit to your home network (LAN) to enable various types of playback and operations as described below.

- Playback of network audio such as Internet Radio and from your media server(s)
- Playback of streaming music services
- Using the Apple AirPlay function
- Operation on this unit via the network
- Operation with the HEOS wireless multi-room sound system
- Firmware Update

For connections to the Internet, contact an ISP (Internet Service Provider) or a computer shop.



- When  is displayed on the display of this unit, this unit is not connected to a network.

Wired LAN

To make connections via wired LAN, use a LAN cable to connect the router to this unit as shown in the figure below.

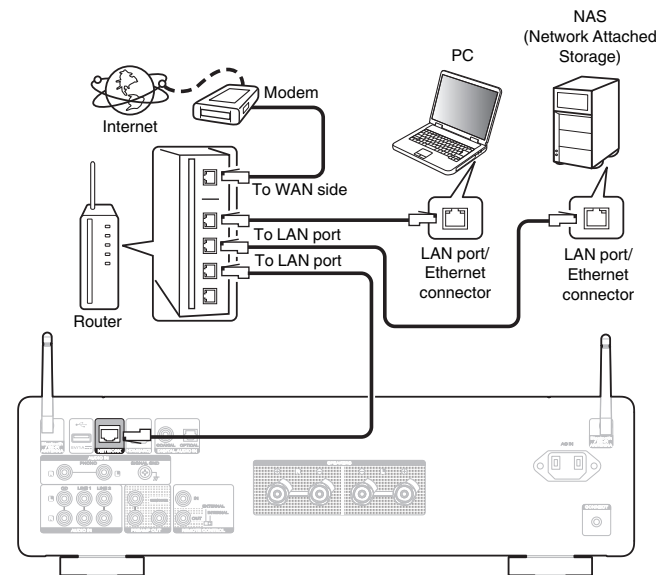

Wireless LAN

When connecting to the network via wireless LAN, connect the external antennas for Bluetooth/wireless connectivity connection to the rear panel and stand them upright.

To connect to a wireless LAN router, download the HEOS app to your smartphone, and set up this unit. (👉 p. 44)

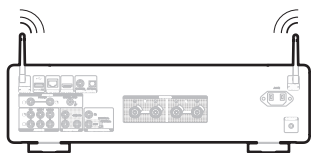
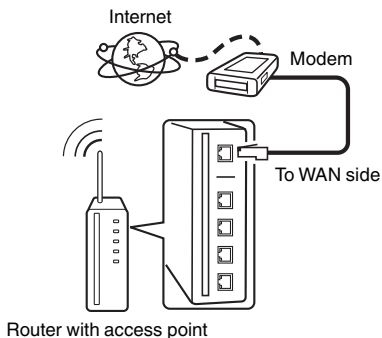

- When using this unit, we recommend you use a router equipped with the following functions:
 - Built-in DHCP server
This function automatically assigns IP addresses on the LAN.
 - Built-in 100BASE-TX switch
When connecting multiple devices, we recommend a switching hub with a speed of 100 Mbps or greater.
- Only use a shielded STP or ScTP LAN cable (readily available at electronics stores). (CAT-5 or greater recommended)
- The normal shielded-type LAN cable is recommended. If a flat-type cable or unshielded-type cable is used, other devices could be affected by noise.

NOTE

- The types of routers that can be used depend on the ISP. Contact your ISP or a computer shop for details.
- This unit is not compatible with PPPoE. A PPPoE compatible router is required if your contracted line is not set using PPPoE.
- Do not connect a NETWORK connector directly to the LAN port/ Ethernet connector on your computer.
- Various online services may be discontinued without prior notice.



Connecting a power amplifier

Connect a power amplifier to the unit to use it as a pre-amplifier.

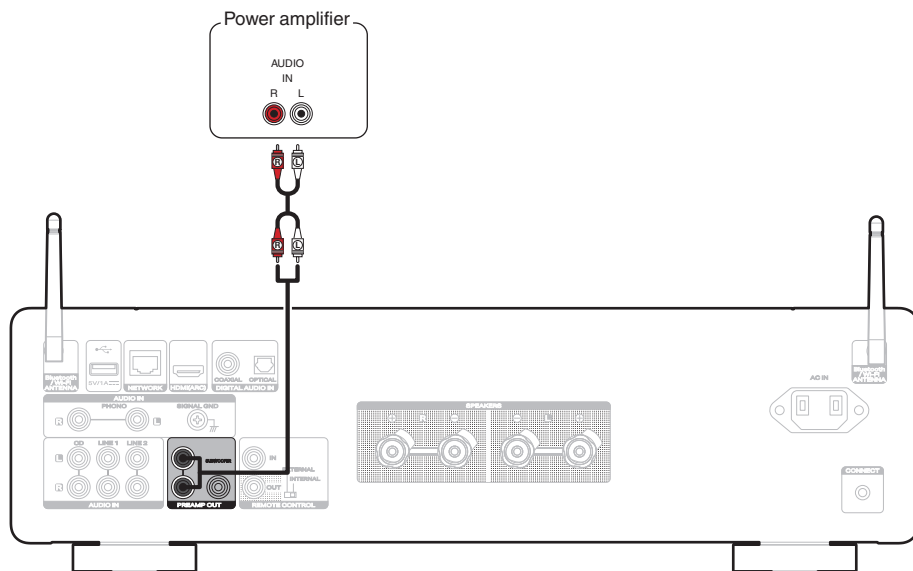

- The volume of the audio signal from the PREAMP OUT connectors is linked to the speakers volume.

NOTE

- Never insert the short-circuiting pin plug into the PREAMP OUT connectors. Doing so could result in damage.



Connecting devices with remote control connectors

Performing operations by RC on this unit without visual contact

You can connect an external IR receiver to the REMOTE CONTROL connectors to perform operations on this unit with the supplied remote control unit without visual contact. This might be necessary if the unit is hidden in a cupboard or corner, so you can't directly point with the remote control unit to the device.

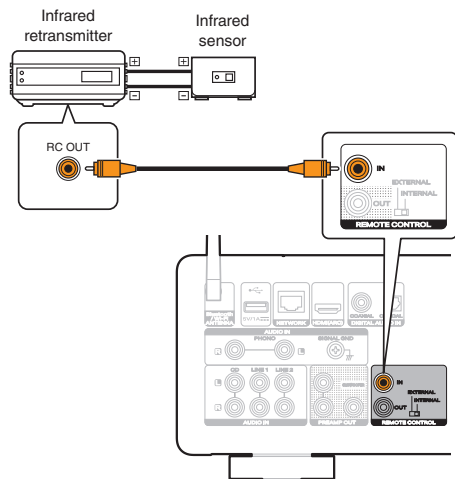

Remotely connecting Marantz audio devices

You can transmit remote control signals simply by connecting a Marantz audio device to the REMOTE CONTROL IN/OUT connectors using the remote connection cable provided with the device.

Set the EXTERNAL/INTERNAL switch on the rear panel of this unit and the connected device as follows.

- Turn this unit's EXTERNAL/INTERNAL switch to "INTERNAL".
- Turn the EXTERNAL/INTERNAL switch of the connected device to "EXTERNAL".

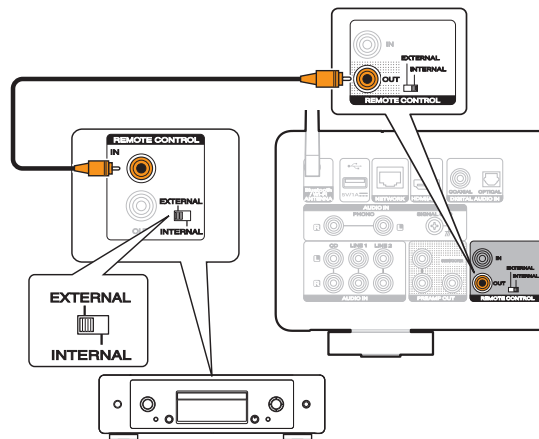



- This setting will disable remote sensor reception of a Marantz audio device.
- To operate the unit, point the remote control at the remote sensor of this unit.
- To use this unit by itself without connecting a Marantz audio device, turn the switch to "INTERNAL".



Connecting the power cord

After completing all the connections, insert the power plug into the power outlet.

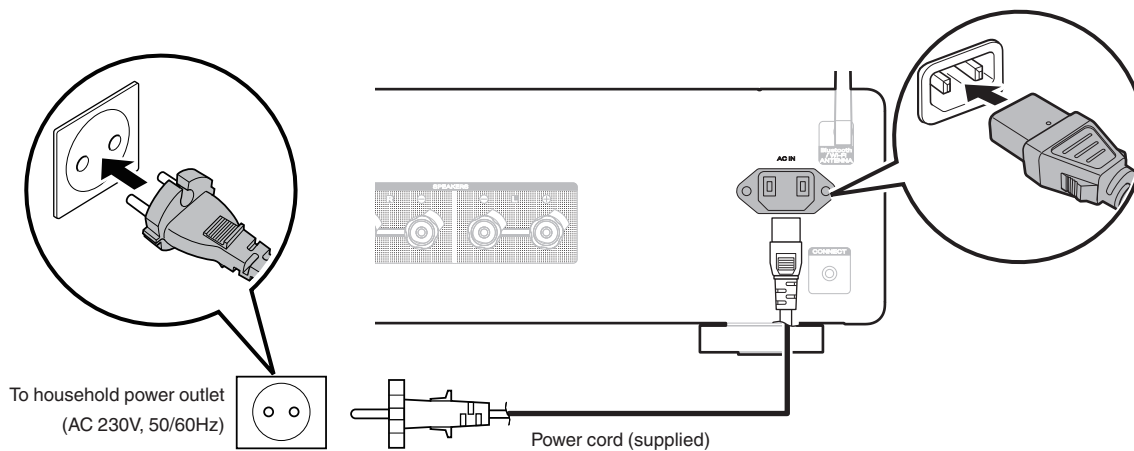

■ Contents

Basic operation

Turning the power on	33
Switching the power to standby	33
Selecting the input source	34
Adjusting the volume	34
Turning off the sound temporarily (Muting)	34

Playback network audio/service

Getting the HEOS app	44
Listening to Internet Radio	54
Playing music stored on your mobile	54
Playing back files stored on PC or NAS	55
Playing music from a USB flash drive	55
AirPlay function	57
Spotify Connect function	60

Playback a device

Playing CDs	35
Listening to music on a Bluetooth device	36
Listening to audio on Bluetooth headphones	39
Playing digital input	42

Convenience functions

Adjusting the tone and balance	61
Playback in source direct mode	61
Playing back HEOS Favorites	62
Switching the display's brightness	62
Using the sleep timer	63



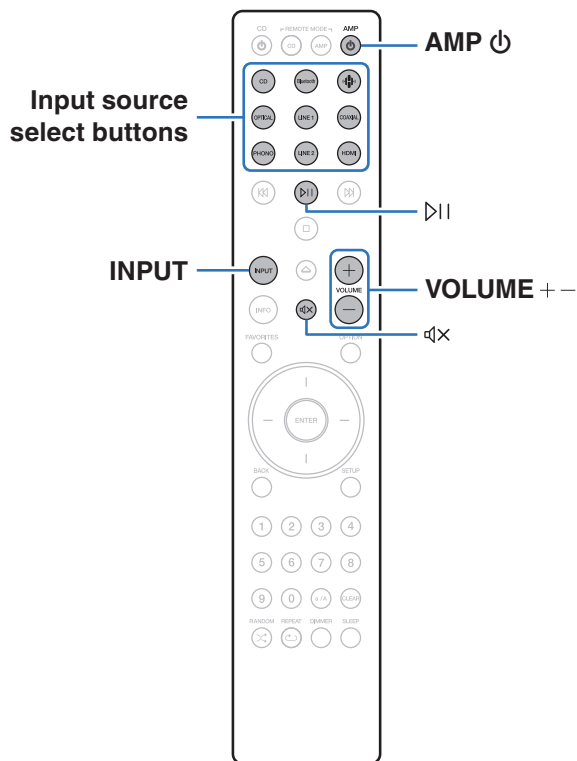

Basic operation



Turning the power on

1 Press AMP  to turn on.



- You can also press  on the main unit to turn on power from standby mode.
- You can also press  to turn on power from standby mode.

Switching the power to standby

1 Press AMP .

The unit switches to standby mode.



- You can also switch the power to standby by pressing  on the main unit.

NOTE

- Power continues to be supplied to some of the circuitry even when the power is in the standby mode. When leaving home for long periods of time or when going on vacation, unplug the power cord from the power outlet.





Selecting the input source

1 Press the input source select button to be played back.

The selected input source appears on the display.



- You can also press INPUT to select the input source.
- You can also select the input source by turning INPUT selector on the main unit.
- If you press the  (HEOS Music), the input source is switched to the one that was previously played on the network. If you cannot access the input source that was previously played from on the network, open "HEOS" on the display.
- To play from a stream or USB flash drive using the network function, use the HEOS app. ( p. 44)
- If you playback from the HEOS app when the power of this device is on, it automatically switches to the input source that is playing.

Adjusting the volume

1 Use VOLUME +— to adjust the volume.

The volume level appears on the display.



- You can also adjust the volume by turning VOLUME on the main unit.

Turning off the sound temporarily (Muting)

1 Press .

"Mute" is displayed on the display.





- To cancel mute, either adjust the sound volume or press  again.

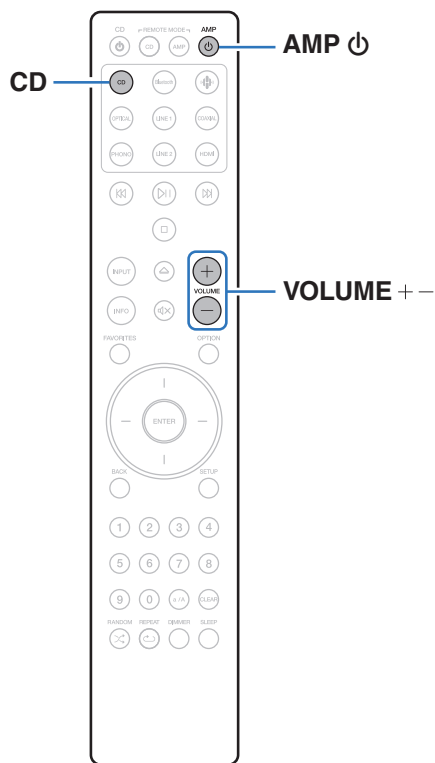

Playing CDs



- 1 Prepare for playback.**
Check the connection, then turn on this units. (“Connecting a playback device” (p. 22))
- 2 Press AMP  to turn the power on.**
- 3 Press the input source select button (CD) to switch the input source to “CD”.**
“CD” is displayed on the display.
- 4 Playback the CD.**
- 5 Use VOLUME   to adjust the volume.**



Listening to music on a Bluetooth device

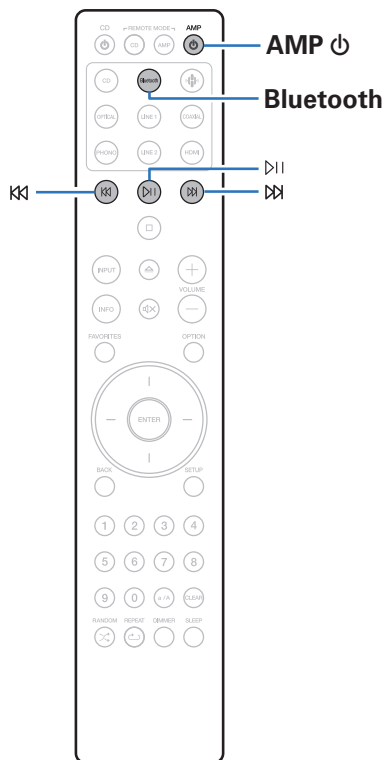

Music files stored on Bluetooth devices such as smartphones, digital music players, etc. can be enjoyed on this unit by pairing and connecting this unit with the Bluetooth device.

Communication is possible up to a range of about 30 m.

NOTE

- To play back music from a Bluetooth device, the Bluetooth device needs to support the A2DP profile.



Listening to music on a Bluetooth device

In order to enjoy music from a Bluetooth device on this unit, the Bluetooth device must first be paired with this unit.

Once the Bluetooth device has been paired, it does not need to be paired again.

1 Prepare for playback.

- ① Connect the supplied external antennas for Bluetooth/wireless connectivity to the Bluetooth/wireless LAN antenna connectors on the rear panel. (☞ p. 11)
- ② Press AMP  to turn on power to the unit.

2 Press Bluetooth.

When playing content via Bluetooth on this unit for the first time, the unit will go into the pairing mode automatically and “Bluetooth Pairing...” will appear on the display of the unit.

3 Activate the Bluetooth settings on your Bluetooth device.



4 Select this unit when its name appears in the list of devices displayed on the screen of the Bluetooth device.

Connect to the Bluetooth device while “Bluetooth Pairing...” is being displayed on the display of the unit.

Perform the connection with the Bluetooth device close to the unit (about 1 m).

5 Play music using any app on your Bluetooth device.

- The Bluetooth device can also be operated with the remote control of this unit.
- The next time the Bluetooth button is pressed on the remote control unit, this unit automatically connects to the last Bluetooth device that was connected.

Operation buttons	Function
	Playback / Pause
	Skip to previous track / Skip to next track



Pairing with other Bluetooth devices

Pair a Bluetooth device with this unit.

- 1 Activate the Bluetooth settings on your Bluetooth device.**
- 2 Press and hold Bluetooth on the remote control unit for at least 3 seconds.**
This unit will go into the pairing mode.
- 3 Select this unit when its name appears in the list of devices displayed on the screen of the Bluetooth device.**



- This unit can be paired with a maximum of 8 Bluetooth devices. When a 9th Bluetooth device is paired, it will be registered in place of the oldest registered device.

NOTE

- To operate the Bluetooth device with the remote control of this unit, the Bluetooth device needs to support the AVRCP profile.
- The remote control of this unit is not guaranteed to work with all Bluetooth devices.
- Depending on the type of Bluetooth device, this unit outputs audio that is coupled to the volume setting on the Bluetooth device.

Reconnecting to this unit from a Bluetooth device

After pairing is completed, the Bluetooth device can be connected without performing any operations on this unit.

This operation also needs to be performed when switching the Bluetooth device for playback.

- 1 If a Bluetooth device is currently connected, deactivate the Bluetooth setting of that device to disconnect it.**
- 2 Activate the Bluetooth setting of the Bluetooth device to be connected.**
- 3 Select this unit from the Bluetooth device list on your Bluetooth device.**
- 4 Play music using any app on your Bluetooth device.**



- When the power of this unit and the Bluetooth function of this unit are turned on, the input source will be automatically switched to "Bluetooth" if a Bluetooth device is connected and is played.
- When the "Network Control" setting of this unit is set to "On" and a Bluetooth device is connected and is played with the unit in the standby state, the power of the unit will be turned on automatically. (🔧 p. 72)



Listening to audio on Bluetooth headphones

You can listen to the sounds that are played back in this device from Bluetooth headphones.

Output audio from connected speakers and Bluetooth headphones simultaneously, or only using Bluetooth headphones.

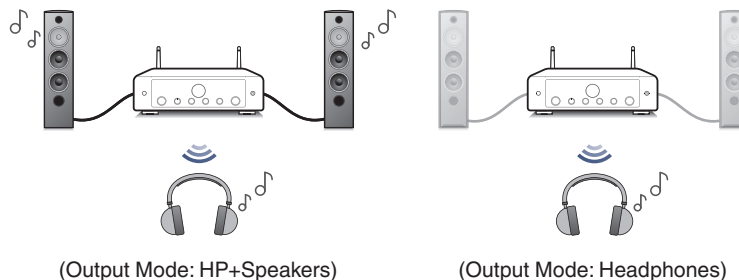

Listening to audio on Bluetooth headphones

- 1 Set “Headphone” to “On” from the “Network” - “Bluetooth” setting in the setup menu. (👉 p. 71)
- 2 Select “Output Mode”, and set audio output method.

HP+Speakers (Default):	Audio is output to Bluetooth headphones and speakers. This simultaneous output is suitable for family movie night and other group activities.
Headphones:	Audio is output to Bluetooth headphones only. This is suitable for listening to music or watching movies by yourself at night when you need to keep quiet.
- 3 Enter pairing mode on the Bluetooth headphones you want to connect to this unit.
- 4 Select “Devices” and select the name of the Bluetooth headphones from the device list.
- 5 Adjust the volume of connected Bluetooth headphones after the connection is completed.



- A2DP profile-compatible Bluetooth speakers can be connected following the same steps used to connect Bluetooth headphones.

NOTE

- Bluetooth headphones volume cannot be adjusted from this unit. Adjust volume of your Bluetooth headphones.
- The settings for “Audio” in the setup menu specified on this unit are not reflected to/in the sound output of Bluetooth headphones.
- The settings for BASS, TREBLE and BALANCE, or the source direct mode specified on this unit are not reflected to/in the sound output of Bluetooth headphones.
- Audio may be delayed when sent over Bluetooth.
- AirPlay and Roon Ready audio cannot be transmitted.
- Bluetooth headphones cannot be connected when use a Bluetooth input source. Furthermore, selecting a Bluetooth input source will terminate the connection between this unit and Bluetooth headphones.
- Bluetooth headphones cannot be connected when this unit is grouped in the HEOS app.
- Bluetooth headphones cannot be connected if a HEOS Built-in device is playing an input source from this unit.

CAUTION:

Using Bluetooth headphones without a volume adjustment function

- In order to avoid hearing loss, do not connect Bluetooth headphones that lack volume adjustment functionality.
- Bluetooth headphone volume may be unexpectedly loud when this unit connects to Bluetooth headphones.
- Bluetooth headphone volume cannot be adjusted from this unit.



Reconnecting to a Bluetooth headphones

Follow any of the steps below to reconnect the most recently used Bluetooth headphones:

- Reconnect to this unit with Bluetooth headphone's reconnect function.
- If "Output Mode" is set to "HP+Speakers", this unit will automatically connect to the most recently used Bluetooth headphones when power is turned on.
- Select the device you wish to connect from the "Devices" under "Bluetooth" in the setup menu. (👉 p. 71)

Disconnecting Bluetooth headphones

Complete any of the following steps to disconnect your Bluetooth headphones:

- Turn off your Bluetooth headphones.
- In the setup menu, go to "Network" - "Bluetooth", and set "Headphone" to "Off". (👉 p. 71)



Playing digital input

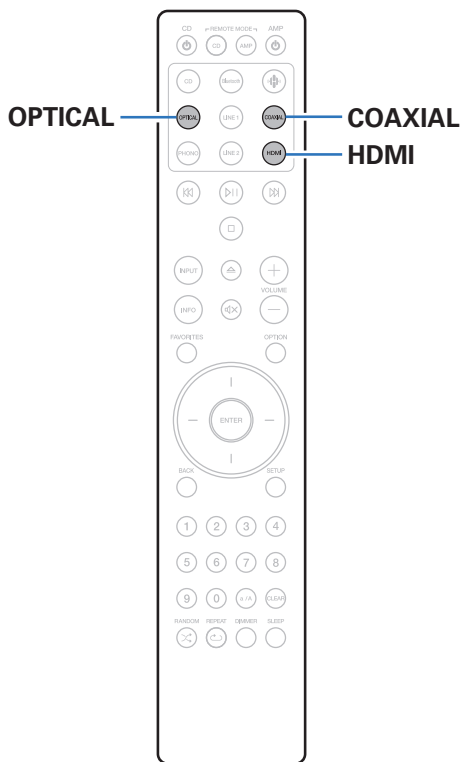

1 Prepare for playback.

Check the connection, then turn on this units. (“Connecting to a device with digital audio connectors” (p. 23))

2 Press HDMI, COAXIAL or OPTICAL to switch the input source to “HDMI”, “COAXIAL” or “OPTICAL”.

3 Play the component connected to this unit.

- If the sampling frequency cannot be detected, “Unlocked” will be displayed.
- “Unsupported” is displayed when audio signals that are not supported by this unit are input.





- When “TV Input” is set in the menu, this unit automatically turns on when the TV connected to the unit is turned on, and the input source switches to “HDMI”, “COAXIAL” or “OPTICAL”. (🔍 p. 68)
- If you connect your TV via the Optical or Coaxial connection, this unit cannot be put to standby when you turn off your TV. If you want to automatically put this device on standby, set “Auto-Standby” in the settings menu. (🔍 p. 69)

NOTE

- Do not input non-PCM signals, such as Dolby Digital, DTS and AAC. This causes noise and could damage the speakers.
- Only the PCM 2-channel setting can be used to play sound from a TV via the ARC function. Set “PCM 2ch” as the audio format in the TV settings.

■ Specifications of supported audio formats

See “Digital input” (🔍 p. 98).

■ HDMI control function

Connect this unit to a TV that supports the HDMI control function with an HDMI cable and enable the HDMI control setting on the TV to perform basic operations on this unit (changing the input source, turning the power on and off, adjusting the volume) with the remote control of the TV.

Refer to “About HDMI” (🔍 p. 102) for more information about the HDMI control function.



Getting the HEOS app

You can use many online music streaming services from the HEOS app. Depending upon your geographical location, there are several options to choose from.

Download the HEOS app for iOS or Android by searching App Store, Google Play store or Amazon Appstore for “HEOS”.



- Specifications of the HEOS app may be changed without prior notice for improvement purposes.



Setting up the HEOS app for the first time with a HEOS built-in device

Once you have placed this unit in your listening room and have downloaded the HEOS app, you are ready to configure this unit for music playback. This involves following a few simple steps to get this unit connected to your existing home network:



- DO NOT connect the Ethernet cable if you are connecting this unit to a wireless network. If you are connecting this unit to a wired network, use an Ethernet cable sold separately to connect this unit to your network or router.

1 Make sure your mobile device is connected to your wireless network (the network you want to connect to this device).

You can check this in the “Settings” - “Wi-Fi” menu of your iOS or Android device.



- Activate the Bluetooth setting on your mobile device.
- If your wireless network is secure, make sure you know the password to join your network.

2 Launch the HEOS app on your mobile device.



3 Tap the “Setup Now” button at the top of the screen.

4 Follow the instructions to add this unit to your wireless network and to select an input on this unit.



Adding the registration of HEOS built-in devices in the HEOS app

The HEOS system is a true multiroom audio system that automatically synchronizes audio playback between multiple HEOS Built-in devices so that the audio coming from different rooms is perfectly in sync and always sounds amazing! You can easily add up to 32 HEOS Built-in devices to your HEOS system.

■ Adding wired HEOS Built-in devices

Just connect the HEOS built-in devices to your home network using an Ethernet cable and the HEOS built-in device will appear on your HEOS app as a new room in the Rooms screen. For information about wired LAN connections, refer to “Connecting to a home network (LAN)” (🔗 p. 26).

At your convenience, you can assign a name to the HEOS Built-in device to indicate which room you have it placed in.

■ Adding wireless HEOS Built-in devices

You can add additional wireless HEOS built-in devices to your HEOS system by selecting “Add Device” from the HEOS app’s settings menu and follow the instructions:

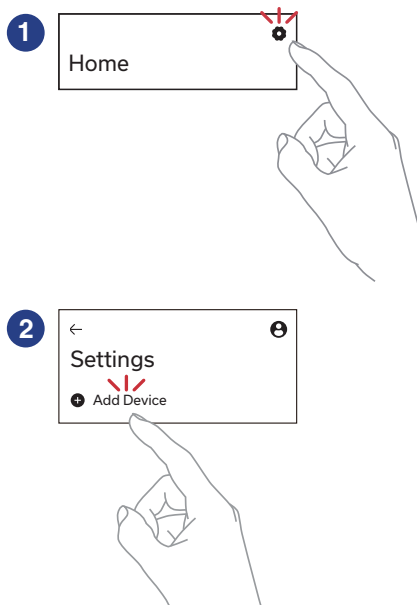

HEOS Account

HEOS Accounts can be registered in “HEOS Account” (👉 p. 47) in the menu of this unit or by tapping “Home” tab - “Settings” icon ⚙️ in the HEOS app.

■ What is a HEOS Account?

A HEOS Account is master account or “keychain” for managing all of your HEOS music services with one single username and password.

■ Why do I need a HEOS Account?

With the HEOS Account you just have to enter your music services login names and passwords one time. This allows you to easily and quickly use multiple controller apps on different devices.

You just log into your HEOS Account on any device and you will have access to all of your associated music services, play history and custom playlists, even if you are at a friend’s house listening to music on their HEOS system.

■ Signing up for a HEOS Account

You will be instructed to sign up for a HEOS Account the first time you try to access any music service from the main “Home” menu of the HEOS app. Follow the instructions in the HEOS app to complete the operation.



- This unit’s HEOS Account setting information is synced with the HEOS app. Change settings and sign out of your account through the HEOS app.

■ Changing your HEOS Account

- 1 Tap the “Home” tab.
- 2 Select the Settings icon ⚙️ in the upper right corner of the screen.
- 3 Select the HEOS Account 👤 icon in the upper right corner of the screen.
- 4 Change your location, change your password, delete your account or sign out of your account.



- This unit automatically syncs when you change your account settings or sign out through the HEOS app. To switch HEOS accounts, play back music from an HEOS app signed in to the account you wish to sync to this unit. The “HEOS Account” switches automatically.



Playing from streaming music services

A music service is an online music company that provides access to vast music collections via free and/or paid subscriptions. Depending upon your geographical location, there are several options to choose from.

NOTE

- The HEOS app and brand is not affiliated with any manufacturer of any mobile device. Availability of music services may vary by region. Not all services may be available at time of purchase. Some services may be added or discontinued from time to time based on decisions of the music service providers or others.

■ Selecting a room/device

- 1 Tap the “Rooms” tab. Select “Marantz MODEL 60n” if there are multiple HEOS devices.



- Tap “Edit” at the top right to switch edit mode. You can change the displayed name.

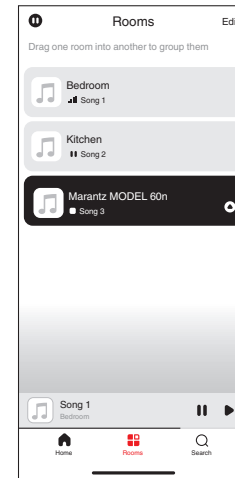

■ Selecting the music track or station from music sources

1 Tap the “Home” tab and select a music source.



- All music services displayed may not be available in your location.

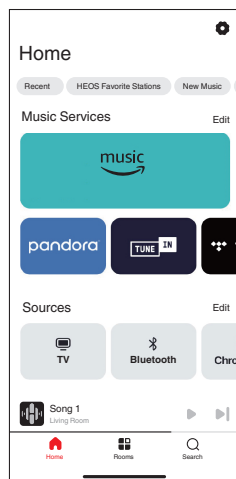

2 Browse the music to play.

After selecting a music track or radio station the app will automatically change to the “Now Playing” screen.



- Set “Network Control” of the settings menu to “On” so that when you are playing back from the HEOS app while this device is in standby, this device turns on automatically. (“Network Control” (p. 72))

Audio file

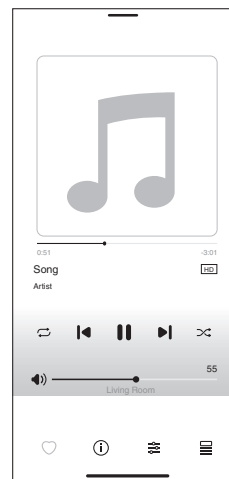

Streaming

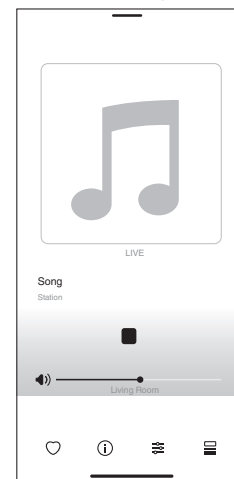

Listening to the same music in multiple rooms

The HEOS system is a true multi-room audio system that automatically synchronizes audio playback between multiple HEOS devices so that the audio coming from different rooms is perfectly in sync and always sounds amazing! You can easily add up to 32 HEOS devices to your HEOS system. You can join or group up to 16 individual HEOS devices into a group of HEOS devices that function as if they were a single HEOS device.

■ Grouping rooms

- 1** Press and hold your finger on room that is not playing music.
- 2** Drag it into the room that is playing music and lift your finger.
- 3** The two rooms will be grouped together into a single device group and both rooms will be playing the same music in perfect sync.

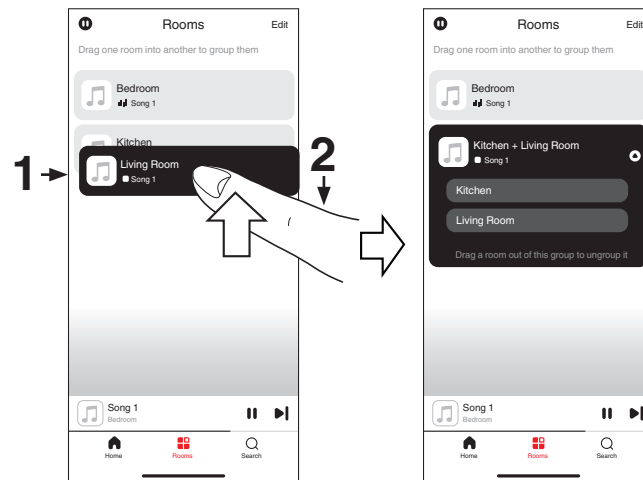

■ Ungrouping rooms

- 1 Press and hold your finger on room that you want to remove from the group.
- 2 Drag it out of the group and lift your finger.

NOTE

- You can not remove the first room that started playing the music before grouping.

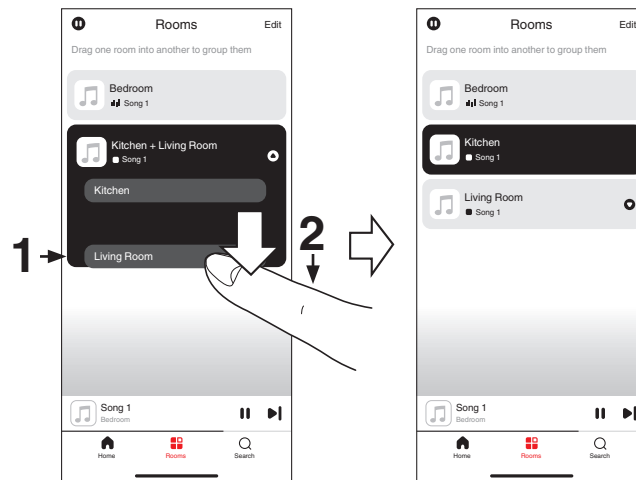

■ Grouping all rooms (party mode)

You can easily group 16 rooms together into Party Mode by using a “pinch” gesture.

- 1** Place two fingers on the screen over the list of rooms.
- 2** Quickly pinch your two fingers together and release.
- 3** All of your rooms will be joined together and begin playing the same music in perfect sync.

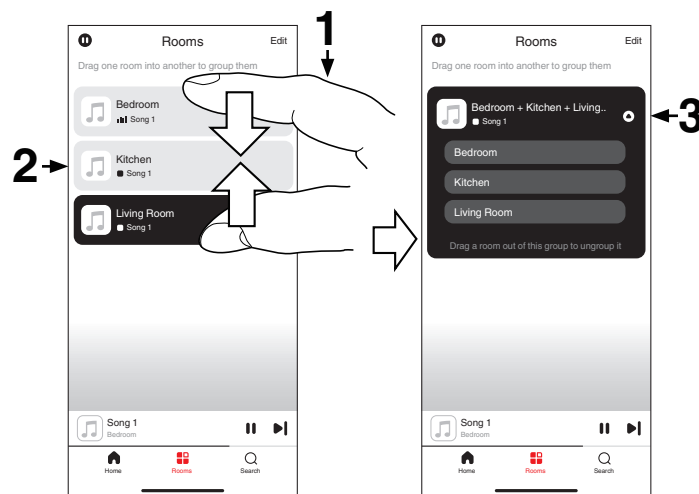

■ Ungrouping all rooms

You can easily ungroup all of your rooms and exit Party Mode by using a “spread” gesture.

- 1 Place two fingers close together on the screen over list of rooms.**
- 2 Quickly spread your two fingers apart from each other and release.**
- 3 All of your rooms will be ungrouped.**

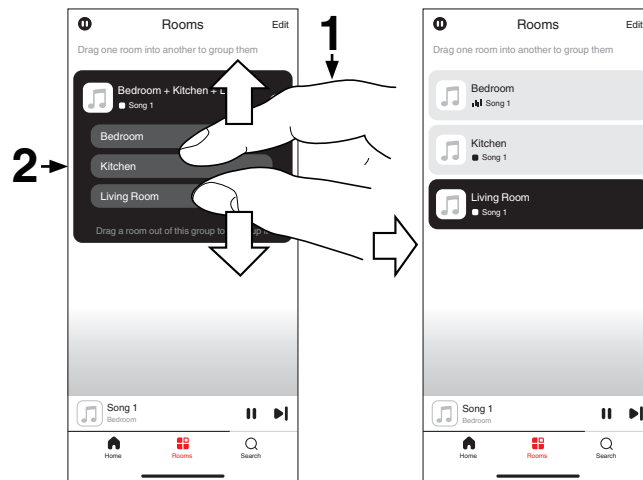

Listening to Internet Radio

Perform this operation on the HEOS app. Download the HEOS app in advance to your iOS or Android device. (📖 p. 44)

The HEOS system includes access to more than 100,000 free internet radio streams from all corners of the globe via the TuneIn radio service. Just select the TuneIn logo from the main “Home” menu and browse among the 100,000 stations neatly organized into popular categories and select a station that appeals to your mood.



- If you have a TuneIn account, you can sign into the TuneIn service under “Settings” - “Music Sources” - “TuneIn”, and access all of your “My Favorites” TuneIn stations.
- For the types and specifications of audio formats that can be played back on this unit, see “Playing back Internet Radio” (📖 p. 101).

NOTE

- The radio station database service may be suspended or be otherwise unavailable without notice.

Playing music stored on your mobile

Perform this operation on the HEOS app. Download the HEOS app in advance to your iOS or Android device. (📖 p. 44)

- 1 Tap the “Home” tab.**
- 2 Select “This iPhone/iPod/iPad/Phone” from “Sources” section.**
- 3 Browse the local music on your phone and select something to play.**



Playing back files stored on a PC or NAS

Perform this operation on the HEOS app. Download the HEOS app in advance to your iOS or Android device. (📖 p. 44)

- 1 Tap the “Home” tab.
- 2 Select “Server” from the “Sources” section.
- 3 Select the name of your networked PC or NAS (Network Attached Storage) server.
- 4 Browse the music on your PC/NAS and select something to play.



- For the types and specifications of audio formats that can be played back on this unit, see “Playing back files stored on a PC and NAS” (📖 p. 100).

Playing music from a USB flash drive

Perform this operation on the HEOS app. Download the HEOS app in advance to your iOS or Android device. (📖 p. 44)

- 1 Insert a FAT32 or NTFS formatted USB flash drive into the USB port on the rear panel of this unit.
- 2 Tap the “Home” tab.
- 3 Select “USB Music” from the “Sources” section.
- 4 Select the name of this unit.
- 5 Browse the music on your USB flash drive and select something to play.





- It may take several minutes for the name of this unit to appear in the “USB Music” list if you have a large number of files on your USB flash drive.
- It is not possible to connect and use a computer via the USB port of this unit using a USB cable.
- For the types and specifications of audio formats that can be played back on this unit, see “Playing back a USB flash drives” (📖 p. 97).

NOTE

- Note that Marantz will accept no responsibility whatsoever for any problems arising with the data on a USB flash drive when using this unit in conjunction with the USB flash drive.
- When a USB flash drive is connected to this unit, the unit loads all of the files on the USB flash drive. Loading may take a while if the USB flash drive contains a large number of folders and/or files.



AirPlay function

Music files stored on your iPhone, iPod touch, iPad, Mac or Windows PC can be played on this unit via the network.



- Input source will be switched to “AirPlay” when AirPlay playback is started.
- You can stop AirPlay playback by choosing other input source.
- The screen may differ depending on the OS and software versions.

This device supports AirPlay 2.

Sync multiple AirPlay 2 compatible devices/speakers for simultaneous playback.

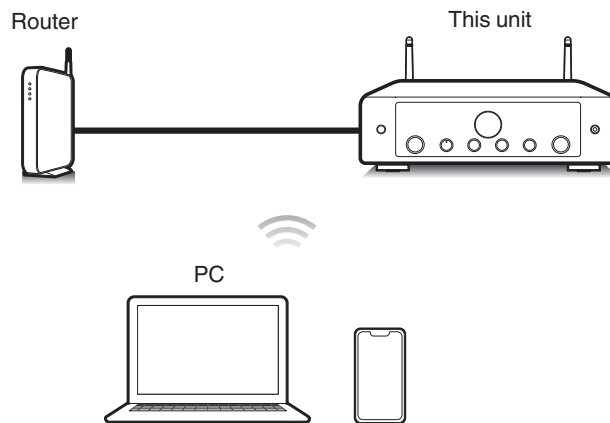

Playing songs from your iPhone, iPod touch, iPad or Mac

You can stream music stored in your “iPhone/iPod touch/iPad/Mac” directly to this unit.

1 Connect your iPhone, iPod touch, iPad or Mac Wi-Fi to the same network as this unit.

- For details, see your device’s manual.

2 Open Apple Music and play music from your iPhone, iPod touch or iPad.

3 Tap or click the AirPlay icon and select this unit.

[Example] iOS 15 or macOS 13

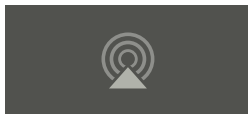

[Example] iOS 10



- You can also use AirPlay to stream music from other applications. Open the Control Center, tap or click the AirPlay icon, then select this unit.
- To use AirPlay, your iOS device must support iOS 10.0.2 or later, or OS X Mountain Lion 10.8 or later.

Playing songs from Windows PC

- 1 Install iTunes 10, or later, on a Windows PC that is connected to the same network as this unit.
- 2 Start iTunes and click the AirPlay icon to select this unit.

[Example] iTunes



3 Choose a song and click play in iTunes.

The music will stream to this unit.



- When “Network Control” is set to “On”, you can turn on this unit by operating iTunes. (☞ p. 72)
- For information about how to use iTunes, also see the Help for iTunes.



Play a song from your iPhone, iPod touch, iPad or Mac on multiple synced devices (AirPlay 2)

Songs from an iPhone, iPod touch, iPad or Mac can be synced with multiple AirPlay 2 supported devices for simultaneous playback.

1 Play the song on your iPhone, iPod touch, iPad or Mac.

AirPlay icon is displayed on the iPhone, iPod touch, iPad or Mac screen.

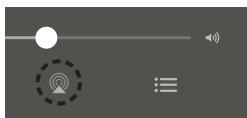

2 Tap or click the AirPlay icon and select this unit.

Displays a list of devices/speakers that can be played back on the same network.

- A circle is displayed to the right of AirPlay 2 compatible devices.

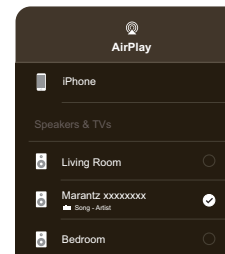

3 Select the devices/speakers you want to use.

- Multiple AirPlay 2 compatible devices can be selected.

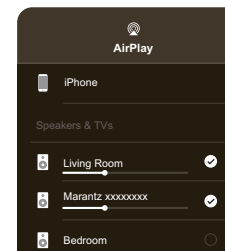

- To use AirPlay 2, your iOS device must support iOS 11.4 or later, or macOS Catalina or later.



Spotify Connect function

Spotify is all the music you'll ever need. Millions of songs available instantly. Just search for the music you love, or let Spotify play you something great. Spotify works on your phone, tablet, computer and home speakers. So you'll always have the perfect soundtrack for whatever you're doing. Now you can enjoy Spotify with your free account as well as Premium account.

Use your phone, tablet or computer as a remote control for Spotify.

Go to www.spotify.com/connect to learn how.

The Spotify software is subject to third party licenses found here:

www.spotify.com/connect/third-party-licenses

Playing Spotify music with this unit

Download the "Spotify App" onto your iOS or Android device beforehand.

- 1 Connect the Wi-Fi settings of the iOS or Android device in the same network as this unit.**
- 2 Launch the Spotify App.**
- 3 Play back the Spotify track.**
- 4 Tap the Spotify icon  to select the unit.**

The music will stream to this unit.

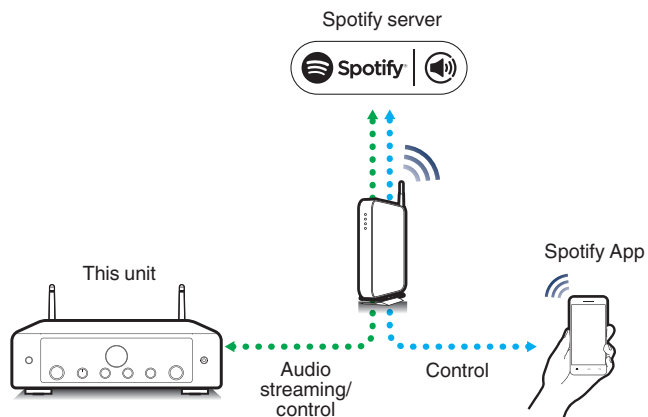

Convenience functions

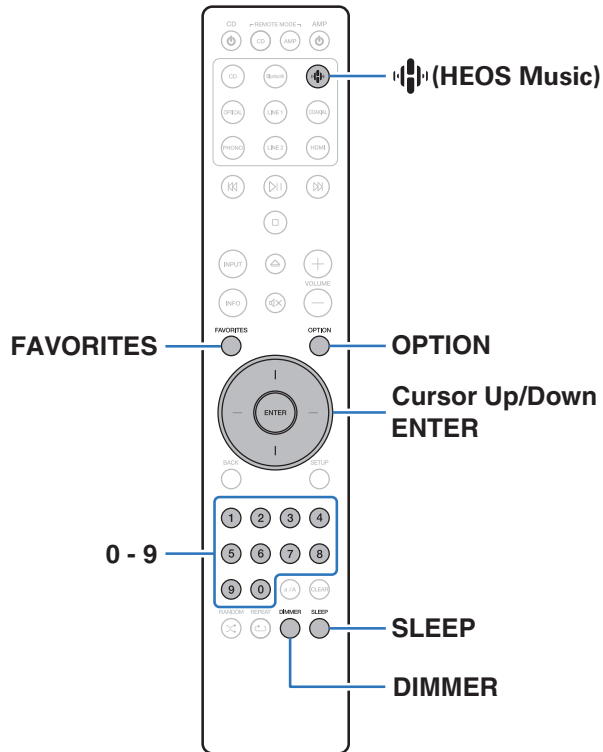

- This section explains how to use convenient functions that can be used for each input source.
- Control of “HEOS Favorites” operations is optimized for the app. For more information on acquiring the app, see “Getting the HEOS app” (📖 p. 44).

Adjusting the tone and balance

- 1 Turn the **SOURCE DIRECT** knob on the main unit and set it to “**SOURCE DIRECT OFF**”.
- 2 Turn the **BASS**, **TREBLE** and **BALANCE** on the main unit to adjust the tone and balance.

Playback in source direct mode

The signal does not pass through the tone adjustment circuitry (BASS, TREBLE and BALANCE), resulting in playback of a higher sound quality.

- 1 Turn the **SOURCE DIRECT** knob on the main unit and set it to “**SOURCE DIRECT ON**”.



Playing back HEOS Favorites

If you register HEOS Favorites on the HEOS app in advance, you can recall your favorite streaming radio stations using the unit's remote control. When using the HEOS Favorites function for the first time on this unit, create a HEOS Account on the HEOS app or sign in to your account to register your HEOS Favorites.

- 1 Press FAVORITES.**
- 2 Use 0 – 9 to select content you would like to playback from your HEOS Favorites.**



- You can select HEOS Favorites numbers 1-10 on the remote control.
- Press 0 to select HEOS Favorites number 10.

Switching the display's brightness

The display brightness can be adjusted between four levels. Switching the display off reduces a source of noise that affects sound quality, enabling higher sound quality playback.

- 1 Press DIMMER.**
 - The brightness of the display switches each time the button is pressed.



- If the buttons are operated when the display is turned off, information is displayed temporarily.
- The display brightness is set to most brightly by default.



Using the sleep timer

You can have the power automatically switched to standby once a set time has elapsed. This is convenient for listening while going to sleep.

1 Press SLEEP during playback and select the setting time.

- The sleep timer can be set to up to 90 minutes, in steps of 10 minutes.
- After about 5 seconds, the setting is entered and the display returns to as it was before.

■ To cancel the sleep timer

1 Press SLEEP to set “Sleep Off”.



- The sleep timer setting is canceled when the unit switches to standby mode.
- To check the time remaining until the sleep timer is activated, press SLEEP.



Menu map

For menu operations, see the following page.

By default, this unit has recommended settings defined. You can customize this unit based on your existing system and your preferences.

Setting items	Detailed items	Description	Page
Audio	Lock Range	Narrowing down the “Lock Range” setting reduces jittering, providing clearer sound.	67
	Volume Limit	Make a setting for maximum volume. The volume cannot be increased above this setting.	67
TV	TV Input	Set the input source to be used when playing audio from the TV through this unit.	68
	Auto-Play	Set the On/Off setting of the “Auto-Play” function that automatically switches the input source when the audio signal specified in “TV Input” is input and playback is performed.	68
	HDMI Power Off Control	Set the “HDMI Power Off Control” function that is keyed to the power off operation of your TV to turn the device’s power to standby.	68
General	Auto-Standby	Sets the unit power to standby when the unit is not in use.	69
	Reset	Various settings are reset to the factory default values.	69



Setting items	Detailed items	Description	Page
Network	Network & USB-A	The network and USB flash drive playback (USB-A) functions can be stopped to prevent noise that affects the sound quality.	70
	Wi-Fi	The Wi-Fi function can be stopped to prevent noise that affects the sound quality.	70
	Bluetooth	Stopping Bluetooth function reduces a source of noise that affects sound quality, enabling higher sound quality playback. It also sets the Bluetooth transmitter settings.	71
	Network Control	Performs the On/Off settings for the network function when in standby mode.	72
	AirPlay Setup	Set this unit to WAC mode. Perform this setup when connecting to a network using an iOS device.	72



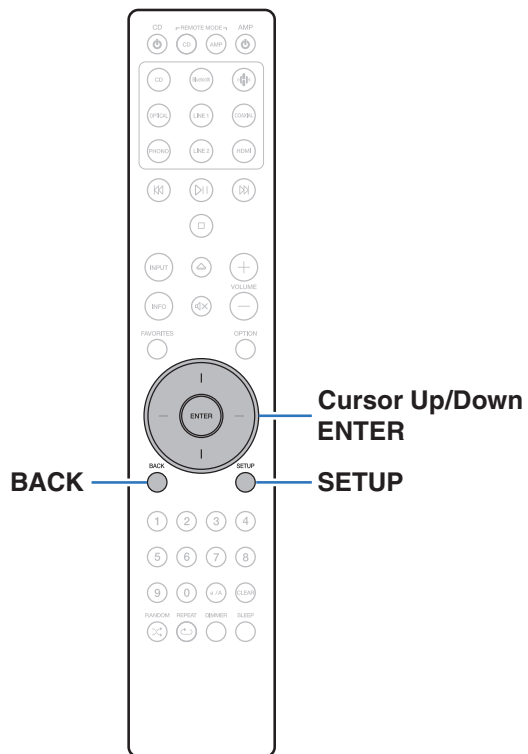

Menu operation

- 1 Press SETUP.**
The menu is displayed on the display.
- 2 Use Cursor Up/Down buttons to select the menu to be set or operated, then press ENTER.**
- 3 Use Cursor Up/Down buttons to change to desired setting.**
- 4 Press ENTER to enter the setting.**
 - To return to the previous item, press BACK.
 - Exiting the Menu, press SETUP while the menu is displayed. The display returns to the normal display.



Audio

Make audio-related settings.

Lock Range

Narrowing down the “Lock Range” setting reduces jittering, providing clearer sound. However, if the “Lock Range” is set too narrow, it may cause intermittent sounds and noise during playback or when switching to a song with a different sampling frequency. If this occurs, broaden the “Lock Range” setting until the music you are listening to sounds normal.

Narrow / Medium / Wide (Default : Wide)



- A separate “Lock Range” setting is recorded for each input source, except for HEOS Music, USB memory and Bluetooth, which have a common setting.
- For analog audio input sources, the “Lock Range” setting cannot be performed.

Volume Limit

Make a setting for maximum volume. The volume cannot be increased above this setting.

Off

(Default):

Do not set a maximum volume. (100)

95 / 90 / 85 / 80



TV

TV Input

Set the input source to be used when playing audio from the TV through this unit. Set this according to the jack on this unit being used to connect to the TV.

None / HDMI ARC / Optical / Coaxial

(Default: HDMI ARC)

Auto-Play

When a TV audio source is input to this unit, the unit automatically switches to the input source set in “TV Input” and the “Auto-Play” function for playing TV audio on this unit is set.

On
(Default) : Enables the “Auto-Play” function.

Off: Disables the “Auto-Play” function.



- The “Auto-Play” function does not work when “TV Input” is set to “None”. Set “TV Input” in advance.
- Depending on your TV, the “Auto-Play” function may not work.

HDMI Power Off Control

Set the “HDMI Power Off Control” function that is keyed to the power off operation of your HDMI connected TV to turn the device’s power to standby.

All
(Default) : Regardless of the input source of this device, if the power of the TV is turned off, the power of this device automatically becomes standby.

HDMI ARC: If the input source is HDMI and you power off the TV, the power of this device automatically becomes standby.

Off: This unit is not linked to the power of the TV.



General

Auto-Standby

Sets the amount of time that must elapse without unit operation or an input signal before the unit goes into standby automatically.

Off:	The unit does not go into standby automatically.
1min:	The unit goes into standby after 1 minutes.
5min:	The unit goes into standby after 5 minutes.
15min (Default):	The unit goes into standby after 15 minutes.
30min:	The unit goes into standby after 30 minutes.
60min:	The unit goes into standby after 60 minutes.
90min:	The unit goes into standby after 90 minutes.

Reset

Perform this procedure if the display is abnormal or if operations cannot be performed. Restores the contents of each setting to the factory settings. Make settings again.

Cancel:	Unit is not initialized.
OK:	Unit is initialized.



Network

Network & USB-A

The network and USB playback (USB-A) functions can be stopped to prevent noise that affects the sound quality. This enables playback with a high sound quality when using the CD playback and D/A converter functions.

On (Default) :	Enables the network and USB memory playback (USB-A) function.
--------------------------	---

Off:	Disables the network and USB memory playback (USB-A) function.
-------------	--



- If you change the “Network & USB-A” setting, this device will reboot.

Wi-Fi

The Wi-Fi function can be stopped to prevent noise that affects the sound quality. Using a wired LAN to connect this unit to the network enables playback with a high sound quality.

On (Default) :	Enables the Wi-Fi function.
--------------------------	-----------------------------

Off:	Disables the Wi-Fi function.
-------------	------------------------------



Bluetooth

Bluetooth

Stopping Bluetooth receiver and transmitter functions reduces a source of noise that affects sound quality, enabling higher sound quality playback.

On (Default) :	Enables the Bluetooth function.
Off:	Disables the Bluetooth function.

Headphone

Enables or disables the Bluetooth headphones transmitter. Perform these settings when you are listening to audio playback of this unit with Bluetooth headphones.

On	Enables the Bluetooth headphones transmitter feature.
Off (Default):	Disables the Bluetooth headphones transmitter feature.

Output Mode

Selects the audio output method.

HP + Speakers (Default) :	Audio is output to Bluetooth headphones and speakers.
Headphones:	Audio is output to Bluetooth headphones only.

Devices

- Available devices are displayed in the list once you start pairing mode on the Bluetooth headphones you want to connect. Select your Bluetooth headphones from the list to pair them.
- This unit can only pair with one Bluetooth headphone at a time. However, up to 8 Bluetooth headphones can be registered. Switch between registered devices from “Devices” in the “Bluetooth” setup menu.
- To remove a saved Bluetooth device from the list, use the Cursor Up/Down buttons to select it, press the OPTION button, and then press the ENTER button when “Forget This Device” is displayed.



- A2DP profile-compatible Bluetooth speakers can be connected following the same steps used to connect Bluetooth headphones.

NOTE

- Bluetooth transmitter and Bluetooth receiver function cannot be used at the same time. Bluetooth transmitter function is not available when listening to music on a Bluetooth device.
- Even when “Headphone” is set to “On”, press Bluetooth on the remote control to select the “Bluetooth” source and enable the Bluetooth receiver function. To listen to music stored on Bluetooth devices such as smartphones on this unit, press Bluetooth on the remote control to switch the input source to Bluetooth, then reconnect the Bluetooth device.
- Menu settings for Bluetooth headphones transmitter are not available when this unit is grouped within the HEOS app.
- Bluetooth headphones cannot be connected if a HEOS Built-in device is playing an input source from this unit.



Network Control

Enables network communication in standby power mode.

On:	Network is on during standby. Main unit operable with a network compatible controller.
Off (Default) :	Suspend network function during standby.



- When using the HEOS app, use with the “Network Control” setting set to “On”.
- Although the setting is “Off” when purchased, it turns “On” automatically when the next operation is performed.
 - Pairing with a Bluetooth device
 - Wireless LAN connection
 - Connect a LAN cable to the NETWORK connector

Once the setting is made in the setting menu, the setting will not be switched automatically even if the above operations are performed.

NOTE

- When “Network Control” is set to “On”, the unit consumes more standby power.

AirPlay Setup

This unit supports the “WAC (Wi-Fi Accessory Configuration)” setup mode of Apple Inc. In the WAC setup mode, use your iOS device (iPhone/iPod/iPad) to connect to the network. By connecting your iOS device with this unit, this unit can be automatically connected to the same network.

1. Select “AirPlay Setup” and press ENTER.
 - This unit switches to the WAC setup mode.
2. At the bottom of the Wi-Fi setup screen for iOS devices, select “Marantz MODEL 60n” from “SET UP NEW AIRPLAY SPEAKER...”.
 - Make sure the iOS device is connected to the wireless LAN (Wi-Fi) router.
3. Select a network to connect this device and press “Next”.
4. Follow the on-screen instructions to complete the connection.
 - When connected, “Connected” is shown on the display.

NOTE

- The firmware version of your iOS device must support iOS 10.0.2 or later.
- The WAC setup mode lasts approximately 15 minutes. If the setup is not completed within 15 minutes, the WAC setup mode is canceled automatically. If you cancel the WAC setup mode manually, press the BACK button.



Connecting by using the WPS button on the router

If you are using a wireless router that supports WPS (Wi-Fi Protected Setup™), connect to the network with the "push button method". (Wi-Fi Protected Setup™ is trademarks of Wi-Fi Alliance.)

- 1 Press the WPS button on your router.**
- 2 Within 2 minutes, press and hold the CONNECT button on the rear panel for 5 seconds.**

"WPS Connecting" is shown on the display and the connection is started.

- When connected, "WPS Connected" is shown on the display.



- You can also press and hold  (HEOS Music) on the remote control for 5 seconds to enter WPS setup mode.



■ Contents

Tips

I want to listen to high sound performance playback	75
I want to adjust the tone myself	75
I want sound playback that is faithful to the original sound	75
I want to play TV audio at higher quality	75
I want to prevent this unit from going into standby by linking to the power off operation of an HDMI connected TV	75
I want to turn the display off	76
Simple operations in the power off state	76
I want the volume not to become too loud by mistake	76
I want to operate a Marantz CD player with this unit's remote control	76

Troubleshooting

Power does not turn on/Power is turned off	78
Operations cannot be performed through the remote control unit	80
Display on this unit shows nothing	80
No sound comes out	81
Sound is interrupted or noise occurs	82
Desired sound does not come out	84
AirPlay cannot be played back	85
USB flash drives cannot be played back	86
Bluetooth cannot be played back	87
The Internet radio cannot be played back	90
Music files on PC or NAS cannot be played back (Music server)	91
Various online services cannot be played	92
Cannot connect to a wireless LAN network	92
Audio from digital devices cannot be played back (HDMI ARC/Coaxial/Optical)	94
The input source switches to "HDMI", "Optical" or "Coaxial"	94
The HDMI control function does not work	94
Update/upgrade error messages	95



Tips

I want to listen to high sound performance playback

- The network and USB memory playback (USB-A) functions can be stopped to prevent noise that affects the sound quality. Set “Network & USB-A” to “Off” in the menu. (👉 p. 70)
- The Wi-Fi function can be stopped to prevent noise that affects the sound quality. Set “Off” to the “Wi-Fi”. (👉 p. 70)
- Stopping Bluetooth function reduces a source of noise that affects sound quality, enabling higher sound quality playback. Set “Off” to the “Bluetooth”. (👉 p. 71)

I want to adjust the tone myself

- Use the BASS, TREBLE and BALANCE knobs to adjust the sound as desired. (👉 p. 61)

I want sound playback that is faithful to the original sound

- Set the source direct mode on. (👉 p. 61)

I want to play TV audio at higher quality

- Connect the HDMI terminal of your TV that supports the ARC function to the HDMI (ARC) terminal of this device and switch the input source to HDMI. (👉 p. 23)
- If you are using a TV that does not support the ARC function or a TV that does not have an HDMI terminal, the TV audio can be played by this device using an Optical or Coaxial connection. (👉 p. 23)
- Only 2-channel linear PCM can be input as the digital audio signal to this unit.

I want to prevent this unit from going into standby by linking to the power off operation of an HDMI connected TV

- Change the “HDMI Power Off Control” setting to “Off”. (👉 p. 68)



I want to turn the display off

- Press the DIMMER button to turn the display off. (👉 p. 62)

Simple operations in the power off state

- Press the ▶|| button to automatically turn the unit's power supply on and start playback of the last selected input source.
- When the "Network Control" function is set to "On", you can perform playback, or other operations through AirPlay or HEOS app. (👉 p. 72)

I want the volume not to become too loud by mistake

- Set the volume upper limit for "Volume Limit" in the menu beforehand. This prevents children or others from increasing the volume too much by mistake. (👉 p. 67)

I want to operate a Marantz CD player with this unit's remote control

- Marantz CD players can be operated with this unit's remote control. Refer to the instruction manual of the CD player too. (👉 p. 16)



Troubleshooting

If a problem should arise, first check the following:

1. Are the connections correct?
2. Is the set being operated as described in the owner's manual?
3. Are the other devices operating properly?



- If steps 1 to 3 above do not improve the problem, restarting the device may improve the problem.
Continue pressing the  button on the unit until "Restart" appears in the display, or remove and re-insert the power cord of the unit.



If this unit does not operate properly, check the corresponding symptoms in this section.

If the symptoms do not match any of those described here, consult your dealer as it could be due to a fault in this unit. In this case, disconnect the power immediately and contact the store where you purchased this unit.



Power does not turn on / Power is turned off

Power is not turned on.

- Check whether the power plug is correctly inserted into the power outlet. (👉 p. 31)
- This unit is in standby mode. Press the  button on the unit or the AMP  button on the remote control. (👉 p. 33)

Power automatically turns off.

- The sleep timer is set. Turn on the power again. (👉 p. 63)
- “Auto-Standby” is set. “Auto-Standby” is triggered when there is no operation for a set amount of time. To disable “Auto-Standby”, set “Auto-Standby” on the menu to “Off”. (👉 p. 69)
- When this unit and a Marantz audio device compatible with the power synchronization function are connected using a remote connection cable, the power of this unit turns off (standby) in synchronization with the power off operation of the device connected to this unit. (👉 p. 29)
- “HDMI Power Off Control” is set. The power of this unit turns off (standby) by linking to the power off operation of an HDMI connected TV. To disable “HDMI Power Off Control”, set “HDMI Power Off Control” on the menu to “Off”. (👉 p. 68)

This unit automatically restarts.

- Switching “Network & USB-A” on/off in the settings menu restarts this unit. (👉 p. 70)

The power turns off and the protection circuit indicator shows one long blink and two short blinks in orange.

- Stop playback on the playback device, and then turn the power off and on again.
- If the problem is not solved by turning the power off and on again, this unit’s amplifier circuit has failed. Unplug the power cord and contact our customer service center.

The power turns off and the protection circuit indicator shows one long blink and three short blinks in orange.

- This unit’s power circuit has failed. Unplug the power cord and contact our customer service center.



The power turns off and the protection circuit indicator shows one long blink and four short blinks in orange.

- The protection circuit has been activated due to a rise in temperature within this unit. Turn the power off, wait about an hour until this unit cools down sufficiently, and then turn the power on again.
- Please re-install this unit in a place having good ventilation.
- Stop playback on the playback device, and then turn the power off and on again.

The power turns off and the protection circuit indicator shows one long blink and five short blinks in orange.

- Check the speaker connections. The protection circuit may have been activated because speaker cable core wires came in contact with each other or a core wire was disconnected from the connector and came in contact with the rear panel of this unit. After unplugging the power cord, take corrective action such as firmly re-twisting the core wire or taking care of the connector, and then reconnect the wire. (☞ p. 19)
- Stop playback on the playback device, and then turn the power off and on again.
- If the problem is not solved by turning the power off and on again, this unit's amplifier circuit or power circuit has failed. Unplug the power cord and contact our customer service center.



Operations cannot be performed through the remote control unit

Operations cannot be performed through the remote control unit.

- Batteries are worn out. Replace with new batteries. (🔍 p. 7)
- Operate the remote control unit within a distance of about 7 m from this unit and at an angle of within 30°. (🔍 p. 7)
- Remove any obstacle between this unit and the remote control unit.
- Insert the batteries in the proper direction, checking the ⊕ and ⊖ marks. (🔍 p. 7)
- The unit's remote control sensor is exposed to strong light (direct sunlight, inverter type fluorescent bulb light, etc.). Move the set to a place in which the remote control sensor will not be exposed to strong light.
- When using a 3D video device, the remote control unit of this unit may not function due to effects of infrared communications between units (such as TV and glasses for 3D viewing). In this case, adjust the direction of units with the 3D communications function and their distance to ensure they do not affect operations from the remote control unit of this unit.
- Press the REMOTE MODE AMP button to switch the remote control operating mode to "AMP". (🔍 p. 13)

Display on this unit shows nothing

Display is off.

- Press the DIMMER button, and change the setting to anything other than off. (🔍 p. 62)



No sound comes out

No sound comes out of speakers.

- Check the connections for all devices. (👉 p. 18)
- Insert connection cables all the way in.
- Check that input connectors and output connectors are not reversely connected.
- Check cables for damage.
- Check that speaker cables are properly connected. Check that cable core wires come in contact with the metal part on speaker terminals. (👉 p. 19)
- Securely tighten the speaker terminals. Check speaker terminals for looseness. (👉 p. 19)
- Check that the proper input source is selected. (👉 p. 34)
- Adjust the volume. (👉 p. 34)
- Cancel the mute mode. (👉 p. 34)
- Check that the correct input source is selected when audio is being input to this unit from an external device. (👉 p. 34)
- Check the digital audio output setting on the connected device. The initial settings may be off depending on the device.
- No sound is output from the speaker terminals or the preout connector when headphones are connected. (👉 p. 9)
- Do not input non-PCM signals, such as Dolby Digital, DTS and AAC. This causes noise and could damage the speakers.
- To playback via a Bluetooth connection, perform pairing between this unit and the Bluetooth device. (👉 p. 36)



Sound is interrupted or noise occurs

During playback from the Internet radio or USB flash drive, sound is occasionally interrupted.

- When the transfer speed of the USB flash drive is slow, sound may occasionally be interrupted.
- The network communication speed is slow or the radio station is busy.

When making a call on mobile phone, noise occurs in audio output on this unit.

- When making a call, keep a distance of 20 cm or longer between mobile phone and this unit.

Sound cuts out when using Wi-Fi connection.

- The frequency band used by the wireless LAN is also used by microwave ovens, cordless telephones, wireless game controllers and other wireless LAN devices. Using such devices at the same time as this unit may cause sound to cut out due to electronic interference. Sound cut out can be improved using the following methods. (👉 p. 26)
 - Install devices that cause interference away from this unit.
 - Turn off the power supply to devices that cause interference.
 - Change the settings of the router channel to which this unit is connected to. (See the instruction manual of the wireless router for details on how to change the channel.)
 - Switch to a wired LAN connection.
- Particularly when you play back large music files, depending on your wireless LAN environment, the playback sound may be interrupted. In this case, make the wired LAN connection. (👉 p. 70)



Sound is interrupted or noise occurs.

- The “Lock Range” setting in the menu is too narrow. Broaden the “Lock Range” setting while listening to music until the music sounds normal. (👉 p. 67)

When playing a record, the sound is distorted.

- Adjust to a proper needle pressure.
- Check the tip of the needle.
- Replace the cartridge.

When playing a record, a humming noise comes out of the speakers.

- Check that the turntable is connected correctly. (👉 p. 22)
- If there is a TV or AV device near the turntable, such devices may affect the playback sound. Install the turntable in a location as far away as possible from the TV or other AV devices.

When playing a record, a humming noise comes out of the speakers when the volume is high. (Howling phenomenon)

- Install the turntable and speakers as far from each other as possible. (👉 p. 22)
- The vibrations from the speakers are being transmitted to the player through the floor. Use cushions, etc., to absorb the speakers' vibrations.



Desired sound does not come out

The volume does not increase.

- The maximum volume is set too low. Set the maximum volume using "Volume Limit" on the menu. (👉 p. 67)

Left/right volume balance is unbalanced.

- Adjust the BALANCE control knob. (👉 p. 61)

No sound is produced from subwoofer.

- Check the subwoofer connections. (👉 p. 21)
- Turn on the subwoofer's power.

The settings of the BASS, TREBLE and BALANCE knobs are not applied.

- The settings of the BASS, TREBLE and BALANCE knobs are not applied to the subwoofer output.
- Turn the SOURCE DIRECT switching knob to turn off source direct mode. (👉 p. 61)

The left and right of stereo sound is reversed.

- Check whether the left and right speakers are connected to the correct speaker terminals. (👉 p. 20)

Sound is not correctly output from the power amplifier connected to the PREAMP OUT connectors.

- Check the power amplifier connections. (👉 p. 28)
- The volume of the audio signal from the PREAMP OUT connectors is linked to the speakers volume. Adjust the volume to a suitable level. (👉 p. 34)



AirPlay cannot be played back

The AirPlay icon is not displayed on iTunes / iPhone / iPod touch / iPad / Mac.

- This unit and PC / iPhone / iPod touch / iPad are not connected to the same network (LAN). Connect it to the same LAN as this unit. (👉 p. 26)
- The firmware on iTunes / iPhone / iPod touch / iPad / Mac is not compatible with AirPlay. Update the firmware to the latest version.
- Set “Network & USB-A” in the menu to “On”. The AirPlay function does not work when “Network & USB-A” is “Off”. (👉 p. 70)

Audio is not output.

- The volume on iTunes / iPhone / iPod touch / iPad / Mac is set to the minimum level. The volume on iTunes / iPhone / iPod touch / iPad / Mac is linked with the volume on this unit. Set a proper volume level.
- The AirPlay playback is not performed, or this unit is not selected. Click the AirPlay icon on the iTunes / iPhone / iPod touch / iPad / Mac screen and select this unit. (👉 p. 58)

Audio is interrupted during the AirPlay playback on iPhone / iPod touch / iPad / Mac.

- Quit the application running in the background of the iPhone / iPod touch / iPad / Mac, and then play using AirPlay.
- Some external factors may be affecting the wireless connection. Modify the network environment by taking measures such as shortening the distance from the wireless LAN access point.



USB flash drives cannot be played back

USB flash drive is not recognized.

- Disconnect and reconnect the USB flash drive. (👉 p. 25)
- Mass storage class compatible USB flash drives are supported.
- This unit does not support a connection through a USB hub. Connect the USB flash drive directly to the USB port.
- The USB flash drive must be formatted to FAT32 or NTFS.
- Not all USB flash drives are guaranteed to work. Some USB flash drives are not recognized. When using a type of portable hard disc drive compatible with the USB connection that requires power from an AC adapter, use the AC adapter that came with the drive.
- Set “Network & USB-A” in the menu to “On”. The USB flash drive playback function does not work when “Network & USB-A” is “Off”. (👉 p. 70)

Files on the USB flash drive are not displayed.

- Files of a type not supported by this unit are not displayed. (👉 p. 97)
- This unit is able to display files in a maximum of eight folder layers. A maximum of 5000 files (folders) can also be displayed for each layer. Modify the folder structure of the USB flash drive.
- When multiple partitions exist on the USB flash drive, only files on the first partition are displayed.

iOS and Android devices are not recognized.

- The USB port of this unit does not support playback from iOS and Android devices.

Files on a USB flash drive cannot be played.

- Files are created in a format that is not supported by this unit. Check the formats supported by this unit. (👉 p. 97)
- You are attempting to play a file that is copyright protected. Files that are copyright protected cannot be played on this unit.
- Playback may not be possible if the album art file size exceeds 2 MB.



Bluetooth cannot be played back

Bluetooth devices cannot be connected to this unit.

- The Bluetooth function in the Bluetooth device has not been enabled. See the Owner's Manual of the Bluetooth device to enable the Bluetooth function.
- Bring the Bluetooth device near to this unit.
- The Bluetooth device cannot connect with this unit if it is not compatible with the A2DP profile.
- Turn the power of the Bluetooth device off and on again, and then try again.
- Set "Bluetooth" in the menu to "On". The Bluetooth function does not work when "Bluetooth" is "Off". (👉 p. 71)
- Set "Network & USB-A" in the menu to "On". The Bluetooth function does not work when "Network & USB-A" is "Off". (👉 p. 70)

Smartphones and other Bluetooth devices cannot be connected.

- Smartphones and other Bluetooth devices cannot be connected when "Headphone" is set to "On". Press Bluetooth on the remote control to switch the input source to Bluetooth, then connect the device. (👉 p. 71)



Cannot connect Bluetooth headphones.

- Bring the Bluetooth headphones near to this unit.
- Turn the power of the Bluetooth headphones off and on again, and then try again.
- Go to “Network” - “Bluetooth”, and set “Headphone” to “On” within the setup menu. (👉 p. 71)
- Make sure this unit is not already connected to another pair of Bluetooth headphones. Check the currently connected Bluetooth headphones in the “Devices” menu. (👉 p. 71)
Disconnect the connected Bluetooth headphones before connecting the ones you want to use.
- Bluetooth headphones cannot be connected if Bluetooth is being used as an input source.
- Bluetooth headphones cannot be connected if this unit is grouped in the HEOS app. Remove this unit from the group to enable Bluetooth headphones connection.
- Bluetooth headphones cannot be connected if a HEOS Built-in device is playing an input source from this unit.
- The Bluetooth headphones cannot connect with this unit if it is not compatible with the A2DP profile.
- Connection and operation are not guaranteed for all Bluetooth-enabled devices.
- This unit can only connect to one Bluetooth headphone at a time. However, up to 8 Bluetooth headphones can be registered. You can switch between registered devices from “Devices” in the “Bluetooth” menu. (👉 p. 71)



The sound is cut off.

- Bring the Bluetooth device near to this unit.
- Remove obstructions between the Bluetooth device and this unit.
- To prevent electromagnetic interference, locate this unit away from microwave ovens, wireless LAN devices and other Bluetooth devices.
- Reconnect the Bluetooth device.

The sound is cut off or noise occurs when using Bluetooth headphones.

- Move the Bluetooth headphones closer to this unit.
- Remove obstructions between the Bluetooth headphones and this unit.
- Reconnect the Bluetooth headphones.
- To prevent electromagnetic interference, locate this unit away from microwave ovens, wireless LAN devices and other Bluetooth devices.
- We recommend using wired LAN to connect this unit and other devices.
- Bluetooth transmits on the 2.4 GHz band which may interfere with Wi-Fi transmitted on this band. Connect this unit and other devices to Wi-Fi network on a 5 GHz band if available on your Wi-Fi router.

Audio is delayed on my Bluetooth headphones.

- This unit cannot adjust audio delay on Bluetooth headphones.



The Internet radio cannot be played back

A list of radio stations is not displayed in the HEOS app.

- The LAN cable is not properly connected, or the network is disconnected. Check the connection status. (👉 p. 26)

Internet Radio cannot be played.

- The selected radio station is broadcasting in a format that is not supported by this unit. Formats that can be played back in this unit are WMA, MP3 and MPEG-4 AAC. (👉 p. 101)
- The firewall function is enabled on the router. Check the firewall setting.
- Check the power of the router is on.
- Some radio stations broadcast silently during some time period. In this case, no audio is output. Wait for a while and select the same radio station, or select another radio station. (👉 p. 54)
- The selected radio station is not in service. Select a radio station in service.

You cannot connect to a radio station that is registered to Favorites with the HEOS app.

- Radio station is not currently in service. Register radio stations in service.



Music files on PC or NAS cannot be played back (Music server)

Files stored on a computer cannot be played.

- Files are stored in a non-compatible format. Record in a compatible format. (👉 p. 100)
- Files that are copyright protected cannot be played on this unit.
- Even if PC is connected to the USB port on this unit, music files on it cannot be played back. Connect PC to this unit through the network. (👉 p. 26)
- Media sharing settings on the server or NAS do not allow this unit. Change the settings to allow this unit. For details, see the owner's manual of the server or NAS.

Server is not found, or it is not possible to connect to the server.

- The computer's or router's firewall is activated. Check the computer's or router's firewall settings.
- Computer's power is not turned on. Turn on the power.
- Server is not running. Launch the server.

The HEOS app does not show the files in the computer or NAS.

- Files of a type not supported by this unit are not displayed. (👉 p. 100)

Music stored on a NAS cannot be played.

- If you use a NAS in conformity with the DLNA standard, enable the DLNA server function in the NAS setting.
- If you use a NAS that does not conform with the DLNA standard, play the music via a PC. Set Windows Media Player's media sharing function and add NAS to the selected play folder.
- If connection is restricted, set audio equipment as the connection target.



Various online services cannot be played

Various online services cannot be played.

- The online service may have been discontinued.

Cannot connect to a wireless LAN network

Cannot connect to the network.

- Make sure your mobile device is connected to your wireless network before setting up this unit. (👉 p. 45)
- You can connect this unit to your network router using an Ethernet cable sold separately. Once connected via Ethernet, the HEOS app should recognize this unit and you can manually move it to your wireless network using “Settings” - “My Devices” - (“Device Name”) - “Network”.
- Shorten the distance from the wireless LAN access point and remove any obstructions to improve access first before re-connecting again. Place the unit away from microwave ovens and other network access points.
- Configure the access point channel settings away from channels that are being used by other networks.
- This unit is not compatible with WEP (TSN).



Cannot connect to a WPS Router.

- Check that the WPS mode of the router is operating.
- After you press the WPS button on the router, within two minutes, long press the CONNECT button on the rear panel for 5 seconds. (🔍 p. 73)
- A router/settings that are compatible with WPS 2.0 standards are required. Set the encryption time to “None”, WPA-PSK (AES) or WPA2-PSK (AES).
- If the router encryption method is WEP/WPA-TKIP/WPA2-TKIP, you cannot connect by using the WPS button on the router. In this case, connect using the HEOS app or connect by sharing the Wi-Fi setting of your iOS device. (🔍 p. 72)

Cannot connect to the network using iPhone/iPod touch/iPad.

- Update the iPhone/iPod touch/iPad firmware to the latest version.
- When configuring the settings via a wireless connection, iOS 10.0.2 or later needs to be supported.

Cannot connect to the network during standby.

- Set “Network Control” of the settings menu to “On”. If “Network Control” is set to “Off”, the network function is suspended during standby. (🔍 p. 72)



Audio from digital devices cannot be played back (HDMI ARC/Coaxial/Optical)

“Unlocked” is displayed.

- When digital audio signals cannot be detected properly, “Unlocked” is displayed. (👉 p. 42)

“Unsupported” is displayed.

- “Unsupported” is displayed when audio signals that are not supported by this unit are input. Check the audio output signal format from your digital device. (👉 p. 42)
- Only the PCM 2-channel setting can be used to play sound from a TV via the HDMI ARC function. Set “PCM 2ch” as the audio format in the TV settings.

The input source switches to “HDMI”, “Optical” or “Coaxial”

The input source automatically switches to “HDMI”, “Optical” or “Coaxial” when the TV connected to this unit is turned on.

- Set “Off” to “Auto-Play”. (👉 p. 68)

The HDMI control function does not work

The HDMI control function does not work.

- You cannot operate devices that are not compatible with the HDMI control function. In addition, depending on the connected device or the settings, the HDMI control function may not work. In this case, operate the external device directly.
- Check that the HDMI control function setting is enabled on TV connected to this unit.



Update/upgrade error messages

If an update/upgrade is interrupted or fails, an error message appears.

Display	Description
Connection failed. Please check your network, then try again.	The network connection is unstable. Connection to the server failed. Check your network environment and try the update again.
Update failed. Please check your network, then try again.	The download of the firmware failed. Check your network environment and try the update again.
Upgrade failed. Please check your network, then try again.	The download of the firmware failed. Check your network environment and try the upgrade again.
Please check your network, unplug and reconnect the power cord, and try again.	The update failed. Press and hold the  on the main unit for more than 5 seconds, or remove and re-insert the power cord. The update restarts automatically.
Please contact customer service in your area.	This unit may be broken. Contact our Customer Service Center in your area.



Factory Restore

When the unit or the network functions do not work properly, operation may be improved by restoring the firmware to the factory defaults.

Perform this operation if it does not work after attempting “General” - “Reset” of the settings menu. (🔧 p. 69)

After performing the Factory Restore, various settings are reset to the default settings. Configure the settings and update the firmware again.

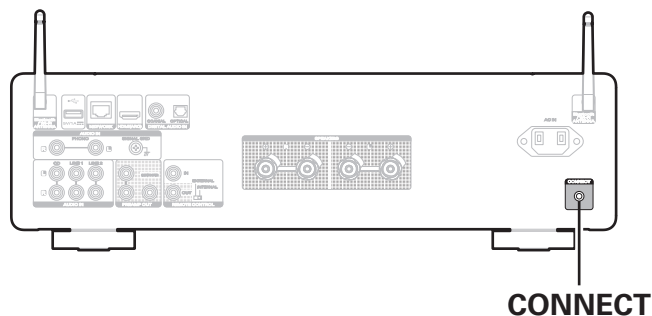

- 1 Unplug the power cord from the power outlet.**
- 2 Plug in the power cord while holding down CONNECT.**
- 3 When “Factory Restore” appears on the display, release the buttons.**

When the firmware restore is complete, “Factory Restore Completed” appears on the display for about 5 seconds, and the unit automatically restarts.



- This operation takes time because it requires reconnecting to the network, restoring and updating the firmware.
- If this operation does not improve the problem, contact our customer service center.

NOTE

- Do not turn off the power until the Factory Restore is complete.

WARNING

By initiating Factory Restore mode, you will be installing limited recovery firmware on this unit. Functionality will remain limited until a firmware update is performed over the Internet. Do not perform a Factory Restore if you do not have this unit connected to your home network.



Playing back a USB flash drives

- This unit is compatible with MP3 ID3-Tag (Ver. 2) standard.
- This unit is compatible with WMA META tags.
- If the image size (pixels) of an album artwork exceeds 500 × 500 (WMA/MP3/Apple Lossless/DSD) or 349 × 349 (MPEG-4 AAC), then music may not be played back properly.

■ Specifications of supported files

	Sampling frequency	Bit rate	Extension
WMA*1	32/44.1/48 kHz	48 – 192 kbps	.wma
MP3	32/44.1/48 kHz	32 – 320 kbps	.mp3
WAV	32/44.1/48/88.2/ 96/176.4/192 kHz	–	.wav
MPEG-4 AAC*1	32/44.1/48 kHz	48 – 320 kbps	.aac/.m4a
FLAC	44.1/48/88.2/ 96/176.4/192 kHz	–	.flac
Apple Lossless*2	44.1/48/88.2/ 96/176.4/192 kHz	–	.m4a
DSD	2.8/5.6/11.2 MHz	–	.dsf/.dff

*1 Only files that are not protected by copyright can be played on this unit.
Content downloaded from pay sites on the Internet are copyright protected. Also, files encoded in WMA format when ripped from a CD, etc. on a computer may be copyright protected, depending on the computer's settings.

*2 The Apple Lossless Audio Codec (ALAC) decoder is distributed under the Apache License, Version 2.0 (<http://www.apache.org/licenses/LICENSE-2.0>).



■ Maximum number of playable files and folder

The limits on the number of folders and files that can be displayed by this unit are as follows.

Item	Media	USB flash drive
Number of folder directory levels *1		8 levels
Number of folders		500
Number of files*2		5000

*1 The limited number includes the root folder.

*2 The allowable number of files may differ according to the USB flash drive capacity and the file size.

Digital input

■ Specifications of supported audio formats

□ HDMI ARC/Coaxial/Optical

	Sampling frequency	Bit length
Linear PCM (2-channel)	32/44.1/48/88.2/96/ 176.4/192 kHz	16/20/24 bits



Playing back a Bluetooth device

This unit supports the following Bluetooth profile.

- A2DP (Advanced Audio Distribution Profile):
When a Bluetooth device that supports this standard is connected, monaural and stereo sound data can be streamed at a high quality.
- AVRCP (Audio/Video Remote Control Profile):
When a Bluetooth device that supports this standard is connected, the Bluetooth device can be operated from this unit.

■ About Bluetooth communications

Radio waves broadcast from this unit may interfere with the operation of medical devices. Make sure you turn off the power of this unit and Bluetooth device in the following locations as radio wave interference may cause malfunctions.

- Hospitals, trains, aircraft, petrol kiosks and places where flammable gases are generated
- Near automatic doors and fire alarms



Playing back files stored on a PC and NAS

- This unit is compatible with MP3 ID3-Tag (Ver. 2) standard.
- This unit is compatible with WMA META tags.
- If the image size (pixels) of an album artwork exceeds 500 × 500 (WMA/MP3/WAV/FLAC) or 349 × 349 (MPEG-4 AAC), then music may not be played back properly.
- A server or server software compatible with distribution in the corresponding formats is required to play music files via a network.

For playing mentioned audio formats via a network a server software, for example Twonky Media Server or jRiver Media Server, needs to be installed on your computer or NAS for full support. There are other server software available too. Please check supported formats.

■ Specifications of supported files

	Sampling frequency	Bit rate	Extension
WMA*1	32/44.1/48 kHz	48 – 192 kbps	.wma
MP3	32/44.1/48 kHz	32 – 320 kbps	.mp3
WAV	32/44.1/48/88.2/96/ 176.4/192 kHz	–	.wav
MPEG-4 AAC*1	32/44.1/48 kHz	48 – 320 kbps	.aac/.m4a
FLAC	44.1/48/88.2/ 96/176.4/192 kHz	–	.flac
Apple Lossless*2	44.1/48/88.2/ 96/176.4/192 kHz	–	.m4a
DSD	2.8/5.6/11.2 MHz	–	.dsf/.dff

*1 Only files that are not protected by copyright can be played on this unit.

Content downloaded from pay sites on the Internet are copyright protected. Also, files encoded in WMA format when ripped from a CD, etc., on a computer may be copyright protected, depending on the computer's settings.

*2 The Apple Lossless Audio Codec (ALAC) decoder is distributed under the Apache License, Version 2.0 (<http://www.apache.org/licenses/LICENSE-2.0>).



Playing back Internet Radio

■ Playable broadcast station specifications

	Sampling frequency	Bit rate	Extension
WMA	32/44.1/48 kHz	48 – 192 kbps	.wma
MP3	32/44.1/48 kHz	32 – 320 kbps	.mp3
MPEG-4 AAC	32/44.1/48 kHz	48 – 320 kbps	.aac/ .m4a

Last function memory

This function stores the settings which were made before going into the standby mode.



About HDMI

This unit supports the following HDMI functions.

- **ARC (Audio Return Channel) function**

Enjoy movies, music, etc., on your TV simply by connecting an ARC function-compatible TV to this unit via HDMI.

- **HDMI control function**

Connect an HDMI control-compatible TV and this unit via HDMI and enable the HDMI control to enable linked control from either device.

- Input source switching

If the TV is turned on, this unit automatically powers on and switches the input source to "HDMI".

- Power off link

The TV power off operation is linked so this unit also turns off.

- Volume adjustment

The volume of this unit can be adjusted using the TV remote control.

- Audio output destination switching

If this unit is turned on, TV audio is output from this unit. If this unit is turned off, TV audio is output from the speakers of the TV.



- Some functions may not operate depending on the connected TV.



Explanation of terms

■ Audio

Apple Lossless Audio Codec

This is a codec for lossless audio compression method developed by Apple Inc. This codec can be played back on iTunes, iPod or iPhone. Data compressed to approximately 60 – 70 % can be decompressed to exactly the same original data.

DSD (Direct-Stream Digital)

One of the audio data recording methods, it is the signal aspect used to store audio signals on a super audio CD, and is Δ - Σ modulated digital audio.

FLAC (Free Lossless Audio Codec)

FLAC stands for Free lossless Audio Codec, and is a lossless free audio file format. Lossless means that the audio is compressed without any loss in quality.

The FLAC license is as shown below.

Copyright (C) 2000,2001,2002,2003,2004,2005,2006,2007,2008,2009
Josh Coalson

Redistribution and use in source and binary forms, with or without modification, are permitted provided that the following conditions are met:

- Redistributions of source code must retain the above copyright notice, this list of conditions and the following disclaimer.
- Redistributions in binary form must reproduce the above copyright notice, this list of conditions and the following disclaimer in the documentation and/or other materials provided with the distribution.
- Neither the name of the Xiph.org Foundation nor the names of its contributors may be used to endorse or promote products derived from this software without specific prior written permission.



THIS SOFTWARE IS PROVIDED BY THE COPYRIGHT HOLDERS AND CONTRIBUTORS "AS IS" AND ANY EXPRESS OR IMPLIED WARRANTIES, INCLUDING, BUT NOT LIMITED TO, THE IMPLIED WARRANTIES OF MERCHANTABILITY AND FITNESS FOR A PARTICULAR PURPOSE ARE DISCLAIMED. IN NO EVENT SHALL THE FOUNDATION OR CONTRIBUTORS BE LIABLE FOR ANY DIRECT, INDIRECT, INCIDENTAL, SPECIAL, EXEMPLARY, OR CONSEQUENTIAL DAMAGES (INCLUDING, BUT NOT LIMITED TO, PROCUREMENT OF SUBSTITUTE GOODS OR SERVICES; LOSS OF USE, DATA, OR PROFITS; OR BUSINESS INTERRUPTION) HOWEVER CAUSED AND ON ANY THEORY OF LIABILITY, WHETHER IN CONTRACT, STRICT LIABILITY, OR TORT (INCLUDING NEGLIGENCE OR OTHERWISE) ARISING IN ANY WAY OUT OF THE USE OF THIS SOFTWARE, EVEN IF ADVISED OF THE POSSIBILITY OF SUCH DAMAGE.

Linear PCM

This is an uncompressed PCM (Pulse Code Modulation) signal. Unlike lossy compression audio sources such as MP3, no audio quality or dynamic range deteriorates.

MP3 (MPEG Audio Layer-3)

This is an internationally standardized audio data compression scheme, using the "MPEG-1" video compression standard. It compresses the data volume to about one eleventh its original size while maintaining sound quality equivalent to a music CD.

MPEG (Moving Picture Experts Group), MPEG-2, MPEG-4

These are the names for digital compression format standards used for the encoding of video and audio. Video standards include "MPEG-1 Video", "MPEG-2 Video", "MPEG-4 Visual", "MPEG-4 AVC". Audio standards include "MPEG-1 Audio", "MPEG-2 Audio", "MPEG-4 AAC".

WMA (Windows Media Audio)

This is the audio compression technology developed by Microsoft Corporation.

WMA data can be encoded using Windows Media® Player.

To encode WMA files, only use applications authorized by Microsoft Corporation. If you use an unauthorized application, the file may not work properly.



Sampling frequency

Sampling involves taking a reading of a sound wave (analog signal) at regular intervals and expressing the height of the wave at each reading in digitized format (producing a digital signal).

The number of readings taken in one second is called the “sampling frequency”. The larger the value, the closer the reproduced sound is to the original.

Speaker impedance

This is an AC resistance value, indicated in Ω (ohms).

Greater power can be obtained when this value is smaller.

Bit rate

This expresses the read amount per 1 second of video/audio data recorded in a disc. A larger number means higher sound quality, but also means a larger file size.

■ Network

AirPlay

AirPlay sends (plays) contents recorded in iTunes or on an iPhone / iPod touch / iPad / Mac to a compatible device via the network.

WEP Key (network key)

This is key information used for encrypting data when conducting data transfer. On this unit, the same WEP key is used for data encryption and decryption, so the same WEP key must be set on both devices in order for communications to be established between them.

Wi-Fi®

Wi-Fi Certification assures tested and proven interoperability by the Wi-Fi Alliance, a group certifying interoperability among wireless LAN devices.

WPA (Wi-Fi Protected Access)

This is a security standard established by the Wi-Fi Alliance. In addition to the conventional SSID (network name) and WEP key (network key), it also uses a user identification function and encrypting protocol for stronger security.

WPA2 (Wi-Fi Protected Access 2)

This is a new version of the WPA established by the Wi-Fi Alliance, compatible with more secure AES encryption.



WPA/WPA2-Personal

This is a simple authentication system for mutual authentication when a preset character string matches on the wireless LAN access point and client.

WPA2/WPA3-Personal

WPA2/WPA3-Personal Mode was defined by Wi-Fi Alliance® to minimize user disruption and provide a gradual migration path to WPA3-Personal while maintaining interoperability with WPA2-Personal only devices.

WPA3-Personal

WPA3-Personal replaces the WPA2-Personal Pre-Shared Key (PSK) authentication with Simultaneous authentication of equals (SAE). Unlike PSK, SAE is resistant to offline dictionary attacks.

Network Names (SSID: Service Set Identifier)

When forming wireless LAN networks, groups are formed to prevent interference, data theft, etc. These groups are based on “SSID (network names)”. For enhanced security, a WEP key is set so that communication is unavailable unless both the “SSID” and the WEP key match. This is suitable for constructing a simplified network.

■ Other

Source direct

Playback with higher fidelity to the source becomes possible, as input audio signals are output by bypassing the audio quality-control circuits (BASS/TREBLE/BALANCE).

Pairing

Pairing (registration) is an operation that is required in order to connect a Bluetooth device to this unit using Bluetooth. When paired, the devices authenticate each other and can connect without mistaken connections occurring.

When using Bluetooth connection for the first time, you need to pair this unit and the Bluetooth device to be connected.

Protection circuit

This is a function to prevent damage to devices within the power supply when an abnormality such as an overload, excess voltage occurs or over temperature for any reason.



Trademark information



Apple, AirPlay, iPad, iPad Air, iPad Pro, iPhone and Mac are trademarks of Apple Inc., registered in the U.S. and other countries.

The trademark "iPhone" is used in Japan with a license from Aiphone K.K.

Use of the Works with Apple badge means that an accessory has been designed to work specifically with the technology identified in the badge and has been certified by the developer to meet Apple performance standards.



The Bluetooth® word mark and logos are registered trademarks owned by the Bluetooth SIG, Inc. and any use of such marks by DEI Sales, Inc. is under license. Other trademarks and trade names are those of their respective owners.



The Wi-Fi CERTIFIED logo is a registered trademark of the Wi-Fi Alliance.

Wi-Fi Certification provides assurance that the device has passed the interoperability test conducted by the Wi-Fi Alliance, a group that certifies interoperability among wireless LAN devices.



The terms HDMI, HDMI High-Definition Multimedia Interface, HDMI trade dress and the HDMI Logos are trademarks or registered trademarks of HDMI Licensing Administrator, Inc.



App Store® is registered in the U.S. and other countries.





Google Play and the Google Play logo are trademarks of Google LLC.

ROON READY

Being Roon Ready means that Marantz uses Roon streaming technology, for an incredible user interface, simple setup, rock-solid daily reliability, and the highest levels of audio performance, without compromise.



Specifications

■ Audio amplifier

RMS Power output (20 Hz – 20 kHz simultaneous drive of both channels) :	60 W x 2 (8 Ω /ohms load) 80 W x 2 (4 Ω /ohms load)
Total harmonic distortion (20 Hz – 20 kHz simultaneous drive of both channels, 8 Ω/ohms load) :	0.02 %
Frequency response (CD, 1 W, 8 Ω/ohms load) :	5 Hz – 100 kHz \pm 3 dB
Damping factor (8 Ω/ohms load, 20 Hz – 20 kHz) :	100 and over
Input sensitivity/impedance:	PHONO (MM): 1.9 mV / 47 k Ω /kohms CD, LINE 1, LINE 2: 200 mV/16 k Ω /kohms
Output voltage:	SUBWOOFER OUT: 220 mV
Maximum allowable PHONO input level (1 kHz) MM :	80 mV
RIAA deviation (20 Hz – 20 kHz) :	\pm 0.5 dB
S/N (IHF-A, 8 Ω/ohms load):	PHONO (MM): 87 dB (5 mV input) CD, LINE 1, LINE 2: 113 dB (rated output)
Tone control:	BASS (50 Hz): \pm 10 dB TREBLE (15 kHz): \pm 10 dB



■ Wireless LAN section

Network type (wireless LAN standard):	Conforming to IEEE 802.11a/b/g/n/ac (Wi-Fi® compliant) *1
Security:	WEP 64 bit, WEP 128 bit WPA/WPA2-PSK (AES) WPA/WPA2-PSK (TKIP) WPA3-SAE (AES)
Used frequency range:	2.4 GHz, 5 GHz

*1 The Wi-Fi® CERTIFIED Logo and the Wi-Fi CERTIFIED On-Product Logo are registered trademarks of the Wi-Fi Alliance.



■ Bluetooth section





Communications system:	Bluetooth Specification Version 5.4
Transmission power:	Bluetooth Specification Power Class 1
Maximum communication range:	Approx. 30 m in line of sight *2
Used frequency range:	2.4 GHz
Modulation scheme:	FHSS (Frequency-Hopping Spread Spectrum)
Supported profiles:	Receiver function A2DP (Advanced Audio Distribution Profile) 1.4 AVRCP (Audio Video Remote Control Profile) 1.5 Transmitter function A2DP (Advanced Audio Distribution Profile) 1.4
Corresponding codec:	SBC
Transmission range (A2DP):	20 Hz – 20,000 Hz

*2 The actual communication range varies depending on the influence of such factors as obstructions between devices, electromagnetic waves from microwave ovens, static electricity, cordless phones, reception sensitivity, antenna performance, operating system, application software etc.



■ General

Operating temperature:	+5 °C - +35 °C
Power supply:	AC 230 V, 50/60 Hz
Power consumption:	220 W
Power consumption in standby modes :	

Standby modes	Setting items in the menu					Power consumption
	TV Input ( p. 68)	Auto-Play ( p. 68)	Wi-Fi ( p. 70)	Bluetooth ( p. 71)	Network Control ( p. 72)	
Normal standby	None	Off	Off	Off	Off	0.3 W
Optical standby	Optical	On	Off	Off	Off	0.3 W
CEC standby	HDMI ARC	On	Off	Off	Off	0.3 W
Wi-Fi connect (5GHz)	None	Off	On	Off	On	2.0 W
Ethernet connect	None	Off	Off	Off	On	1.5 W
Bluetooth connect	None	Off	Off	On	On	1.5 W
All standby	HDMI ARC	On	On	On	On	2.0 W

- For purposes of improvement, specifications and design are subject to change without notice.



■ Dimensions (Unit : mm)

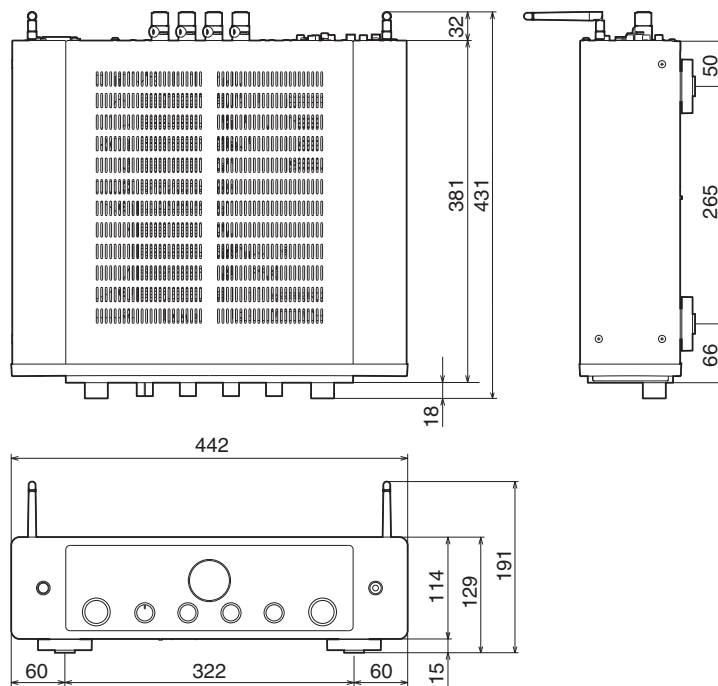

■ Weight : 13 kg

Index

A		M		R	
AirPlay	57	Menu map	64	Rear panel	10
Auto Standby	69	N		Remote control unit	13
B		NAS	55, 100	S	
Bluetooth device	36	Network settings	70	Sleep timer	63
D		P		Spotify	60
Display's brightness	62	Pairing	36	T	
F		PC	26, 55, 100	Tips	75
Front panel	8	Q		Troubleshooting	77
H		Queue	49	U	
HEOS Account	47			USB flash drive	25, 55
HEOS Favorites	62			W	
I				Wi-Fi settings	70
Input source	34			Wired LAN	26, 70
Internet Radio	54			Wireless LAN	27, 70



marantz

3520 10995 00ASA

© 2024 Masimo. All Rights Reserved.