

SONY®

5-027-087-12(1)

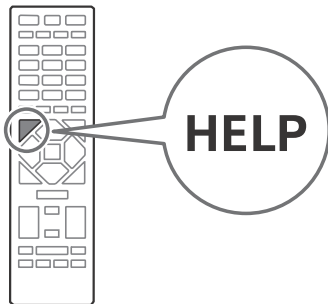

LCD Monitor



Reference Guide	GB
Guide de référence	FR
Guía de referencia	ES
Referentiegids	NL
Referenzanleitung	DE
Guia de referência	PT
Guida di riferimento	IT
Referensmaterial	SE
Referencevejledning	DK
Viiteopas	FI
Referanseveiledning	NO
Przewodnik	PL
Οδηγός αναφοράς	GR
Başvuru Kılavuzu	TR
Справочник	RU
Довідковий посібник	UA

BRAVIA

FW-100BZ40J / 75BZ30J / 65BZ30J / 55BZ30J / 50BZ35J
FW-50BZ30J / 43BZ35J / 43BZ30J / 32BZ30J

Table of Contents

IMPORTANT NOTICE	2
Safety Information	2
Connection Diagram	4
Remote Control and LCD Monitor	7
Settings	8
Pro mode	8
Recommended settings	9
Control functions	10
RS-232C	10
IP	11
Appendix	13
Extended software	13
Installing the LCD Monitor to the Wall	14
Troubleshooting	15
Specifications	15

About Manuals

This LCD Monitor comes with the following manuals. Please retain the manuals for future reference.

Setup Guide

- LCD Monitor installation and setup.



Reference Guide (this manual) / Safety Documentation

- Safety information, remote control, troubleshooting, wall-mount installation, specification, etc.



Help

Find more troubleshooting and other useful information directly from your LCD Monitor. Press **HELP** on the remote control to display a list of topics.



Setting menus are subject to change without notice.

IMPORTANT - Read the End User Software Licence Agreement before using your Sony product. Using your product indicates your acceptance of the End User Software Licence Agreement. The software licence agreement between you and Sony is available online at Sony website (<https://www.sony.net/tv-software-licenses/>) or on your product screen. Go to [Settings] → [System] → [About] → [Legal information] → [Notices and licences].

Note

- Before operating the LCD Monitor, please read the "Safety Information".
- Read the supplied safety documentation for additional safety information.
- Images and illustrations used in the Setup Guide and this manual are for reference only and may differ from the actual product.

Location of the identification label

Labels for the LCD Monitor Model No., Production Date (year/month) and Power Supply rating are located on the rear of the LCD Monitor or package.

For models with supplied mains adaptor:
Labels for mains adaptor Model No. and Serial No. are located on the bottom of mains adaptor.

IMPORTANT NOTICE

Notice for Radio Equipment

Hereby, Sony Corporation declares that the radio equipment types FW-100BZ40J, FW-75BZ30J, FW-65BZ30J, FW-55BZ30J, FW-50BZ35J, FW-50BZ30J, FW-43BZ35J, FW-43BZ30J, FW-32BZ30J are in compliance with Directive 2014/53/EU. The full text of the EU declaration of conformity is available at the following internet address: <https://compliance.sony.eu>

Hereby, Sony Corporation declares that the radio equipment types FW-100BZ40J, FW-75BZ30J, FW-65BZ30J, FW-55BZ30J, FW-50BZ35J, FW-50BZ30J, FW-43BZ35J, FW-43BZ30J, FW-32BZ30J are in compliance with the UK relevant statutory requirements. The full text of the declaration of conformity is available at the following internet address: <https://compliance.sony.co.uk>

For this radio equipment, the following restrictions on putting into service or of requirements for authorization of use apply in AT, BE, HR, CY, CZ, DK, EE, FI, FR, DE, EL, HU, IE, IT, LV, LT, LU, MT, NL, PL, PT, SK, SI, ES, SE, UK, UK (NI), IS, LI, NO, CH, BG, RO, TR, AL, BA, MK, MD, RS, ME, Kosovo :

5150 - 5350 MHz band is restricted to indoor operations only.

Safety Information

Installation/Set-up

Install and use the LCD Monitor in accordance with the instructions below in order to avoid any risk of fire, electric shock or damage and/or injuries.

Installation

- The LCD Monitor should be installed near an easily accessible mains socket.
- Place the LCD Monitor on a stable, level surface to prevent it from falling over and causing personal injury or property damage.
- Install the LCD Monitor where it cannot be pulled, pushed, or knocked over.

- Install the LCD Monitor so that the LCD Monitor's Table-Top Stand does not protrude out from the LCD Monitor stand (not supplied). If the Table-Top Stand protrudes out from the LCD Monitor stand, it may cause LCD Monitor set to topple over, fall down, and cause personal injury or damage to the LCD Monitor.

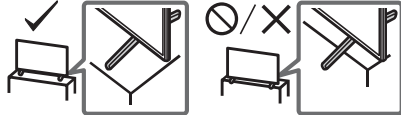

Transporting

- Before transporting the LCD Monitor, disconnect all cables.
- Two or more people (four or more people for FW-100BZ40J) are needed to transport a large LCD Monitor.
- When transporting the LCD Monitor by hand, hold it as shown below. Do not put stress on the LCD panel and the frame around the screen.
- When lifting or moving the LCD Monitor, hold it firmly from the bottom.

FW-100BZ40J

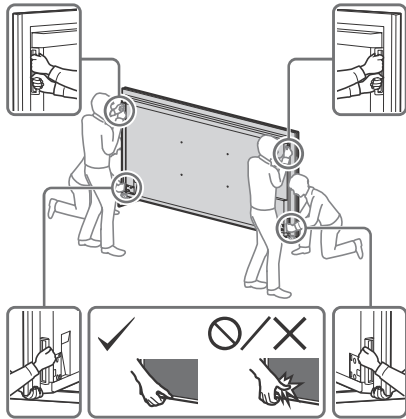

FW-75BZ30J / 65BZ30J / 55BZ30J / 50BZ35J / 50BZ30J / 43BZ35J / 43BZ30J / 32BZ30J

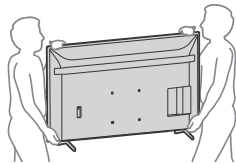

- When transporting the LCD Monitor, do not subject it to jolts or excessive vibration.
- When transporting the LCD Monitor for repairs or when moving, pack it using the original carton and packing material.

Topple prevention

FW-100BZ40J

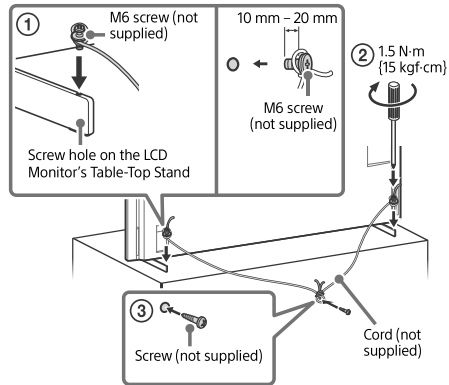

GB

FW-75BZ30J / 65BZ30J / 55BZ30J / 50BZ35J / 50BZ30J / 43BZ35J / 43BZ30J

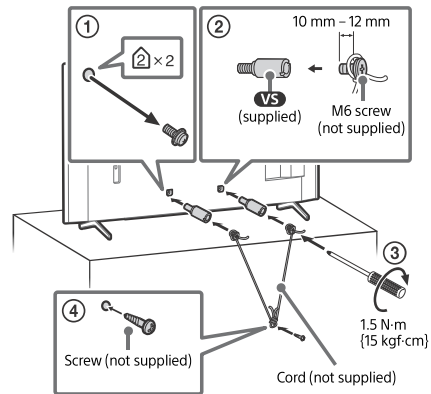

FW-32BZ30J

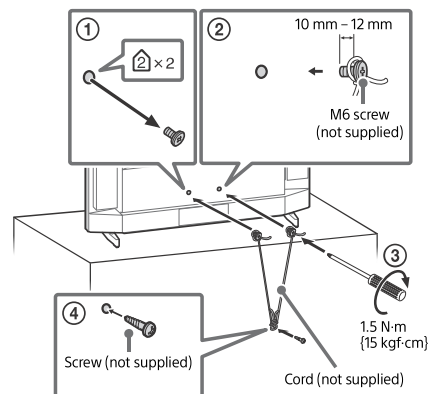

Connection Diagram

Note

- Terminals and labels may vary depending on region/country/LCD Monitor model.

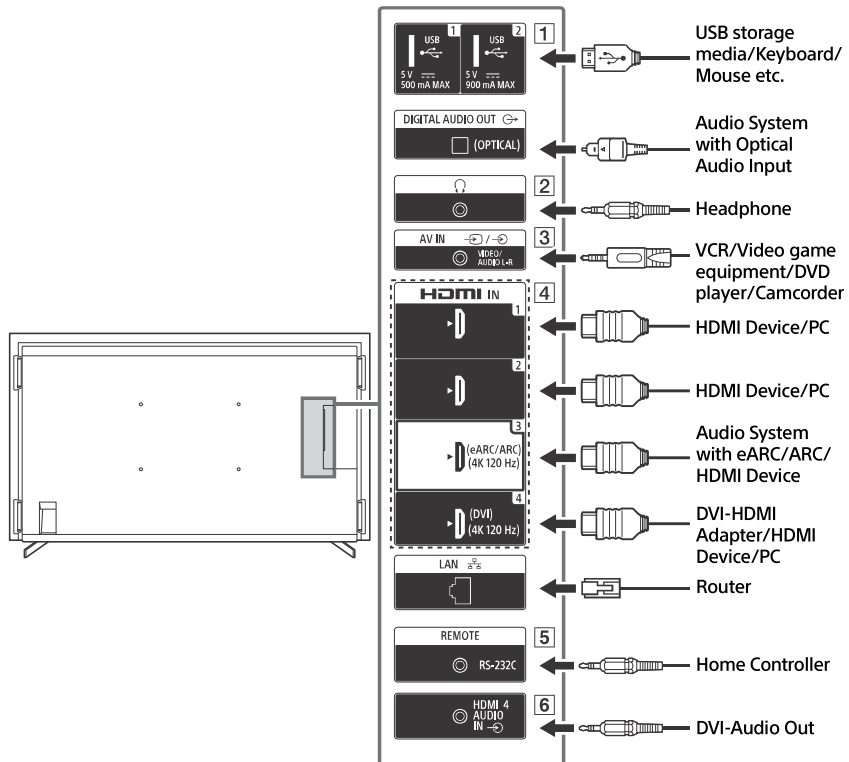

FW-100BZ40J / 50BZ35J / 43BZ35J

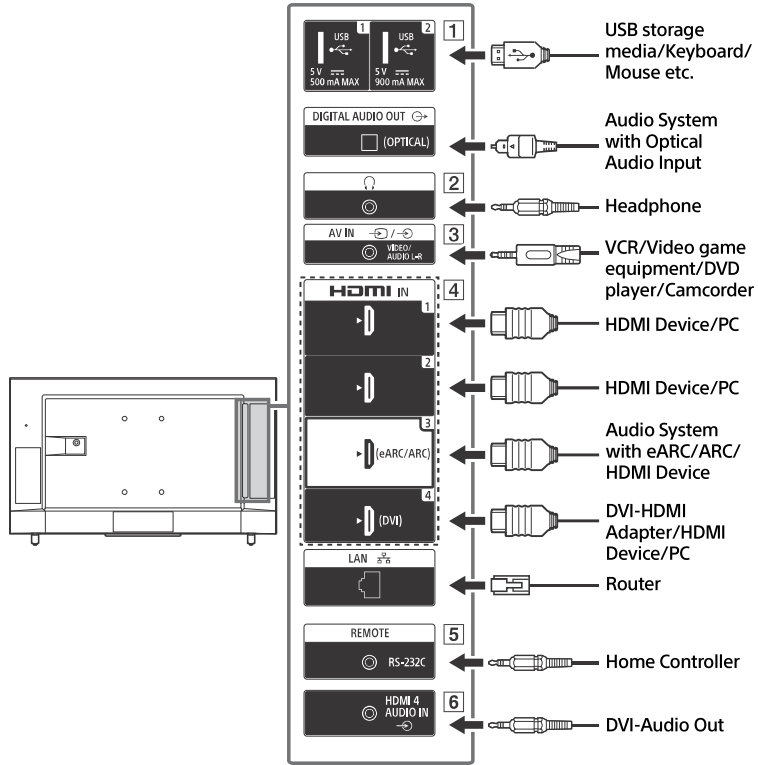

FW-75BZ30J / 65BZ30J / 55BZ30J / 50BZ30J / 43BZ30J / 32BZ30J



GB

1  **USB 1**,  **USB 2**

- Connecting a large USB device may interfere with other connected devices beside it.

2  **(Headphone)**

- Supports 3-pole stereo mini jack only.
- You cannot output sound from both the headphone and the LCD Monitor speakers at the same time.

3  **AV IN**

- For a composite connection, use an Analogue Extension Cable (not supplied).

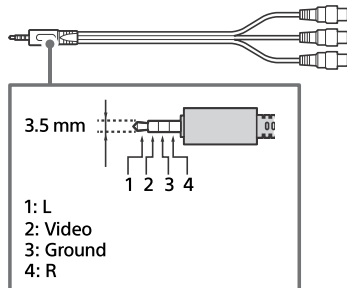

4 **HDMI IN 1/2/3/4**

- HDMI interface can transfer the digital video and audio on a single cable.
- If the device has a DVI jack, connect it to HDMI IN 4 through a DVI - HDMI adaptor interface (not supplied), and connect the device's audio out jack to HDMI 4 AUDIO IN.

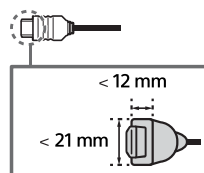

HDMI IN 3 eARC/ARC (Enhanced Audio Return Channel/Audio Return Channel)

- Connect your audio system to the HDMI IN 3 to route LCD Monitor audio to your audio system. An audio system that supports HDMI eARC/ARC can send video to the LCD Monitor, and receive audio from the LCD Monitor via the same HDMI cable. If your audio system does not support HDMI eARC/ARC, an additional connection with DIGITAL AUDIO OUT (OPTICAL) is necessary.
- Use the HDMI cable with Ethernet to connect audio system with eARC.

5 **REMOTE RS-232C**

- Terminal for serial communication. For details, see "Control functions".

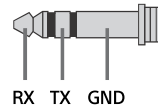

6  **HDMI 4 AUDIO IN**

- If the device has a DVI jack, connect it to HDMI IN 4 through a DVI - HDMI adaptor interface (not supplied), and connect the device's audio out jack to HDMI 4 AUDIO IN.

Remote Control and LCD Monitor

The remote control shape, layout, availability and function of remote control buttons may vary depending on your region/country/LCD Monitor model/LCD Monitor settings.

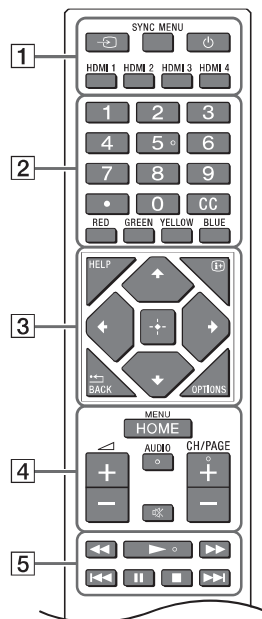

- 1** **(Input select)**: Display and select the input source, etc.

SYNC MENU: Display the BRAVIA Sync Menu.

(Power)

HDMI 1/2/3/4

- 2** **Number buttons**

(dot)

CC

Colour buttons

- 3** **HELP**: Display the Help menu.

(Screen display): Display information.

/BACK

OPTIONS: Displays a list of functions that can be used at that time.

(Navigation D-Pad): On screen menu navigation and selection.

- 4** **HOME/MENU**

+/- (Volume)

AUDIO: Select the sound of multilingual source or dual sound (depend on programme source).

(Mute)*

CH/PAGE +/-

- 5**

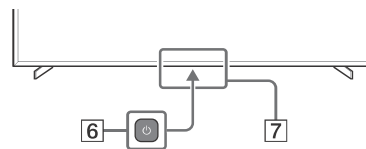

- 6** **(Power)**

- 7** **Remote Control sensor / Light sensor / LED**

* Accessibility shortcut is available by pressing and holding (Mute).

GB

Settings

Pro mode

In [Pro mode], you can use various convenient functions for professional use. Here, we introduce how to change to [Pro mode] and typical functions of [Pro mode].

Pro mode

Normal mode: This is the default mode. [Pro mode] functions are not available in this mode.

Pro settings mode: This mode allows you to set various settings of [Pro mode] functions.

Pro mode: This is the operation mode for professional use where you can use the [Pro mode] functions.

How to change the mode



When the Monitor is in Normal mode and Pro settings mode

- Go to [Home (Menu)] → [Apps] → [Pro mode tool], then select the mode you want to change.

When the Monitor is in the Pro mode

- Press the activation keys described below on the remote control in order within a one second interval.

After restarting the Monitor, the mode changes to [Pro settings mode].

Activation key:  (Screen display) /  (Mute) /  +/- (Volume +/-) / **HOME/MENU**

*Initially you cannot change the mode from [Pro mode tool] in [Pro mode]. If you want to change the mode from [Pro mode tool], go to [Pro settings] → [Function restrictions] → [Apps] and change [Pro mode tool] to [Enable] in [Pro settings mode].

Introduction of the Pro mode functions

In [Pro mode], you can use various convenient functions. Typical [Pro mode] functions are introduced below.

– Setting Monitor operation when turning the AC power on

You can set the operation of the Monitor when unplugging and reinserting the AC power plug.

– Optimized display of the PC input screen

The screen displays the PC input screen with optimum size according to the PC format.

– Power supply control and automatic input switching by HDMI signal detection

If you turn on the Monitor when the HDMI device is connected, you can change to the connected HDMI input automatically.

– Settings of the displaying menu when pressing the HOME/MENU button

You can select the menu displayed when pressing the **HOME/MENU** button on the remote control.

– Initial input source designation when starting the Monitor

You can designate the initial input source when starting the Monitor.

– Pro mode lock

You can protect the settings of [Pro mode] by using a PIN.

– Initial/maximum volume setting

You can set the initial and maximum volume of the Monitor.

– Restriction of the Monitor operation on the remote control

You can restrict the Monitor operation using the remote control.

– **Restriction of external inputs**

You can restrict the use of external inputs.

– **Restriction of using applications**

You can restrict the use of Monitor applications.

How to set Pro mode functions

Go to [Home (Menu)] → [Settings] → [Pro settings] when the Monitor is in [Pro settings mode].*

*Varies depending on the version of the OS.

GB

Recommended settings

This section introduces recommended settings when using the Monitor for professional use.

Setting ECO features

1 Go to [Settings] → [System] → [Power and energy].

- Set [Idle TV power off] to [Off].

Setting IP features

2 Go to [Settings] → [Network & Internet] → [Home network setup] → [IP control].

- Set [Authentication] to [Normal and Pre-Shared Key].
- Set [Simple IP control] to [On].

Automatic Software Download

3 Go to [Settings] → [System] → [About] → [System software update].

- Set [Automatically check for update] to [Off].

Picture settings

4 Go to [Settings] → [Display & Sound] → [Picture].

- Set [Light sensor] to [Off].
- Select [Picture mode] according to usage.

[Vivid]: When using the digital signage display

[Custom]: When displaying the original image as is

[Graphics]: When displaying the PC screen

Control functions

RS-232C

You can control the Monitor from an external service via RS-232C. The RS-232C connection is briefly explained in this page.

Interface

Establish the RS-232C connection to the Monitor by using a 3.5 mm stereo mini plug.

3.5 mm Stereo mini plug

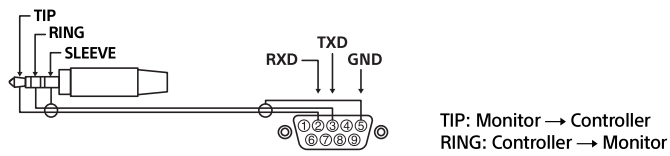

Connection settings

When establishing the RS-232C connection, make connection settings as below.

Baud rate	9600 bps
Data	8 bit
Parity	None
Start bit	1 bit
Stop bit	1 bit
Flow control	None

Data format

We introduce the data format for the RS-232C communication below.

(a) Requests from the controller to the Monitor

No.	Item	Value	
1	Header	0x8C	: Control
2	Category	0x00	(fixed)
3	Function	0xXX	
4	Length	0xXX	(=Data X+1 byte)
5	Data 1	0xXX	
:	:	0xXX	
:	:	0xXX	
X+4	Data X	0xXX	
X+5	Check Sum	0xXX	

(b) Responses from the Monitor to the controller

No.	Item	Value	
1	Header	0x70	Answer
2	Answer	0x00	Completed (Normal End)
		0x01	: Limit Over (Abnormal End-Exceed maximum value)
		0x02	: Limit Over (Abnormal End-Exceed minimum value)
		0x03	: Command Canceled (Abnormal end)
		0x04	: Parse Error (Data Format Error)
3	Check Sum	0xXX	

GB

Command example

Examples of RS-232C communication command are explained below.

Control	Head	Category	Function	Length	Data 1	Data X	Checksum
Power on/ off	0x8C	0x00	0x00	0x02	0x00 (off)	-	0x8E
					0x01 (on)	-	0x8F
HDMI input selection	0x8C	0x00	0x02	0x03	0x04 (HDMI)	0x01 (#1)	0x96
						0x02 (#2)	0x97
						0x03 (#3)	0x98
						0x04 (#4)	0x99

For more details on RS-232C, please contact your sales representative.

IP

You can control the Monitor via IP from an HTML5/Android application on the Monitor or on the external device. You can manage and monitor information of input/power, start and terminate applications, control the display such as input source and volume. You can also restrict commands by the authentication function.

Supported IP protocol

Protocol name	Layer	Format	Authentication	Explanation
REST API	HTTP	JSON-RPC	Yes	The APIs whose purpose is device control.
IRCC-IP	HTTP	SOAP	Yes	Infrared Compatible Control over Internet Protocol. The technology and formats to transmit remote control commands via the Internet.
Simple IP control	TCP	Byte stream	N/A	Only typical functions are supported.

Monitor settings

When using [IP control], set the Monitor as follows first.

Go to [Settings] → [Network & Internet] → [Home network setup] → [IP control].

For REST API and IRCC-IP,

- Select [Authentication].
- Set [Pre-Shared Key] if needed.

For Simple IP control,

- Enable [Simple IP control].

Example of HTTP request and response for REST API

Here is the example of a request and response to acquire the power status to the Monitor (IP address: 192.168.0.1 Pre-shared Key "1234").

URL

http://192.168.0.1/sony/system

Request

```
POST /sony/system HTTP/1.1
Host: 192.168.0.1
Content-Type: application/json; charset=UTF-8
Content-Length: 70
X-Auth-PSK: 1234

{"method": "getPowerStatus", "params": [], "id": 50, "version": "1.0"}
```

Response

```
HTTP/1.1 200 OK
Content-Type: application/json; charset=UTF-8
Content-Length: 44

{"result": [{"status": "active"}], "id": 50}
```

For more details on [IP control], please contact your sales representative.

Appendix

Extended software

You can use the Monitor more conveniently by using extended software. This page introduces an example of extended software.
For more details, please contact your sales representative.

GB

Software for office Monitors

Provides convenient functions for using the Monitor as an office Monitor connected to a PC in a conference room or the like.

Function examples:

- Power management/Power supply monitoring functions.
- White board function.
- System linked with the conference room reservation system.
- Presentation timer.
- You can change inputs or turn the power on/off without the remote control.

Software for digital signage

When using the Monitor as a digital signage display, the software provides convenient functions.

Function examples:

- Digital signage distribution management function to multiple Monitors via the network.
- Easy signage playback function with USB memory.
- Contents and playlist management function.
- Flexible delivery schedule setting by time and day of the week.

Installing the LCD Monitor to the Wall

Using the optional Wall-Mount Bracket (SU-WL850 or SU-WL450)* (not supplied)

To Customers:

For product protection and safety reasons, Sony strongly recommends that installation of your LCD Monitor be performed by Sony dealers or licensed contractors. Do not attempt to install it yourself.

To Sony Dealers and Contractors:

Provide full attention to safety during the installation, periodic maintenance and examination of this product.

Wall-Mount Bracket Installation Information

For instructions on Wall-Mount Bracket installation, see the Installation Information (Wall-Mount Bracket) on the product page for your LCD Monitor model.

<https://www.sony.eu/support>

- Follow the instruction guide provided with the Wall-Mount Bracket for your model. Sufficient expertise is required in installing this LCD Monitor, especially to determine the strength of the wall for withstanding the LCD Monitor's weight.
- Sony is not liable for any damage or injury caused by mishandling or improper installation.
- Only qualified service personnel should carry out wall-mount installations.
- For safety reasons, it is strongly recommended that you use Sony accessories, including:
 - Wall-Mount Bracket SU-WL850
 - Wall-Mount Bracket SU-WL450
- Be sure to use the screws supplied with the Wall-Mount Bracket when attaching the Wall-Mount Bracket to the LCD Monitor. The supplied screws are designed as indicated by illustration when measured from the attaching surface of the Wall-Mount Bracket. The diameter and length of the screws differ depending on the Wall-Mount Bracket model. Use of screws other than those supplied may result in internal damage to the LCD Monitor or cause it to fall, etc.

FW-75BZ30J / 65BZ30J / 55BZ30J / 50BZ35J / 50BZ30J / 43BZ35J / 43BZ30J

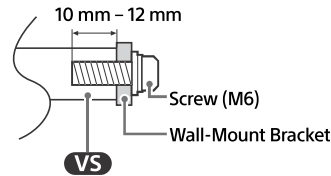

FW-32BZ30J

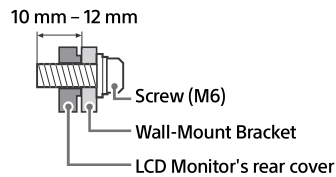

- Be sure to store the unused screws and Table-Top Stand in a safe place until you are ready to attach the Table-Top Stand. Keep the screws away from small children.

* Only on limited region/country/LCD Monitor model.

Using the optional Wall-Mount Bracket (Except SU-WL850 or SU-WL450) (not supplied)

This LCD Monitor's instruction manual only provides the steps to prepare the LCD Monitor for Wall-Mount installation before it is installed on the wall.

Your LCD Monitor can be mounted to a wall using a suitable Wall-Mount Bracket (not supplied). If the Table-Top Stand is attached to the LCD Monitor, the LCD Monitor may require detaching the Table-Top Stand.

Prepare the LCD Monitor for the Wall-Mount Bracket before making cable connections.

For product protection and safety reasons, Sony strongly recommends that installation of your LCD Monitor on the wall be performed by qualified professionals. Do not attempt to install it yourself.

- Follow the instruction guide provided with the Wall-Mount Bracket for your model. Sufficient expertise is required in installing this LCD Monitor, especially to determine the strength of the wall for withstanding the LCD Monitor's weight.
- The screws for installing the Wall-Mount Bracket to the LCD Monitor are not supplied.

- The length of the screw for Wall-Mount Bracket differs depending on the Wall-Mount Bracket thickness. Please refer to below illustration.

FW-100BZ40J

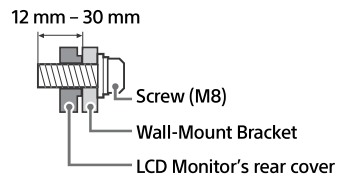

FW-75BZ30J / 65BZ30J / 55BZ30J / 50BZ35J / 50BZ30J / 43BZ35J / 43BZ30J

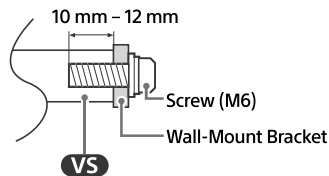

FW-32BZ30J

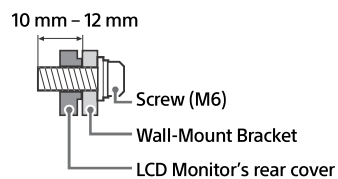

Troubleshooting

General troubleshooting for issues like: black screen, no sound, frozen picture, LCD Monitor does not respond, or network is lost, do the following steps.

GB

- 1 Restart your LCD Monitor by pressing the power button on the remote control for about five seconds. The LCD Monitor will restart. If the LCD Monitor does not recover, try unplugging the mains lead then press the power button on the LCD Monitor and release it. Wait for two minutes, and plug in the mains lead.
Or, press the power button on the LCD Monitor for about 40 seconds until the LCD Monitor turns off.
- 2 Refer to the Help menu by pressing **HELP** on the remote control.
- 3 Connect your LCD Monitor to the Internet and perform a software update. Sony recommends you to keep your LCD Monitor software updated. Software updates provide new features and performance improvements.

When you plug in the LCD Monitor, the LCD Monitor may not be able to turn on for a while even if you press the power button on the remote control or the LCD Monitor.

It takes time to initialize the system. Wait for about one minute, then operate it again.

The remote control does not function.

- Replace the batteries.

Specifications

System

Panel system: LCD (Liquid Crystal Display) Panel, LED Backlight

Sound output:

FW-32BZ30J: 5 W + 5 W

FW-100BZ40J / 75BZ30J / 65BZ30J / 55BZ30J / 50BZ35J / 50BZ30J / 43BZ35J / 43BZ30J: 10 W + 10 W

Wireless technology

Protocol IEEE 802.11a/b/g/n/ac

Bluetooth® Version 4.2

Frequency band(s)

Frequency range	Output power
Wireless LAN (LCD Monitor)	
2400-2483.5 MHz	< 20.0 dBm
5150-5250 MHz	< 23.0 dBm
5250-5350 MHz	< 20.0 dBm
5470-5725 MHz	< 20.0 dBm
5725-5850 MHz	< 13.9 dBm
Bluetooth® (LCD Monitor)	
2400-2483.5 MHz	< 10.0 dBm

Input/Output jacks

AV IN

Video/Audio input (mini jack)

HDMI IN 1/2/3/4 (HDCP 2.3-compatible)

Video (FW-100BZ40J / 50BZ35J / 43BZ35J only):

4096 × 2160p (50, 60 Hz)^{*1*2}, 4096 × 2160p (24 Hz)^{*1}, 3840 × 2160p (50, 60 Hz)^{*2}, 3840 × 2160p (24, 25, 30 Hz), 1080p (30, 50, 60, 100, 120 Hz), 1080/24p, 1080i (50, 60 Hz), 720p (30, 50, 60 Hz), 720/24p, 576p, 480p, PC Formats

3840 × 2160p (100, 120 Hz)^{*2*3}

Video (FW-75BZ30J / 65BZ30J / 55BZ30J / 50BZ30J / 43BZ30J / 32BZ30J only):

4096 × 2160p (50, 60 Hz)^{*1*2}, 4096 × 2160p (24 Hz)^{*1}, 3840 × 2160p (50, 60 Hz)^{*2}, 3840 × 2160p (24, 25, 30 Hz), 1080p (30, 50, 60 Hz), 1080/24p, 1080i (50, 60 Hz), 720p (30, 50, 60 Hz), 720/24p, 576p, 480p, PC Formats

Audio:

In eARC (Enhanced Audio Return Channel) mode

7.1 channel linear PCM: 32/44.1/48 kHz
16 bits, Dolby Digital, Dolby Digital Plus, DTS, Dolby TrueHD, DTS-HD MA, Dolby Atmos, DTS:X Master Audio

Except eARC mode

5.1 channel linear PCM: 32/44.1/48/88.2/96/176.4/192 kHz 16/20/24 bits, Dolby Audio, Dolby Atmos, DTS

eARC/ARC (Enhanced Audio Return Channel/ Audio Return Channel) (HDMI IN 3 only)^{*4}

In eARC mode

7.1 channel linear PCM: 32/44.1/48 kHz
16 bits, Dolby Digital, Dolby Digital Plus, DTS, Dolby TrueHD, DTS-HD MA, Dolby Atmos, DTS:X Master Audio

In ARC mode

Two channel linear PCM: 48 kHz 16 bits, Dolby Audio, Dolby Atmos, DTS

DIGITAL AUDIO OUT (OPTICAL)

Digital optical jack (Two channel linear PCM: 48 kHz 16 bits, Dolby Audio, DTS)

HDMI 4 AUDIO IN

Analogue audio input (Stereo mini jack)

(Stereo mini jack)

Headphone

USB 1, USB 2

USB port 1 supports High Speed USB (USB 2.0)

USB port 2 supports Super Speed USB (USB 3.1 Gen 1)

LAN

10BASE-T/100BASE-TX connector (Depending on the operating environment of the network, connection speed may differ. The communication rate and quality are not guaranteed.)

19.5 V (FW-32BZ30J only)

Mains adaptor input

REMOTE

RS-232C, mini jack

This jack is for receiving the external control signal.

Power, Product Fiche and others

Power requirements

Except models with supplied mains adaptor

220 V – 240 V AC, 50 Hz

Models with supplied mains adaptor only

19.5 V DC with mains adaptor

Rating: Input 220 V – 240 V AC, 50 Hz

Energy Efficiency Class^{*5}

FW-100BZ40J: A+

FW-75BZ30J: A

FW-65BZ30J: A

FW-55BZ30J: B

FW-50BZ35J: A

FW-50BZ30J: B

FW-43BZ35J: B

FW-43BZ30J: A

FW-32BZ30J: B

Screen size (measured diagonally) (Approx.)

FW-100BZ40J: 252.8 cm / 100 inches

FW-75BZ30J: 189.3 cm / 75 inches

FW-65BZ30J: 163.9 cm / 65 inches

FW-55BZ30J: 138.8 cm / 55 inches

FW-50BZ35J: 125.7 cm / 50 inches

FW-50BZ30J: 125.7 cm / 50 inches

FW-43BZ35J: 108.0 cm / 43 inches

FW-43BZ30J: 108.0 cm / 43 inches

FW-32BZ30J: 80.1 cm / 32 inches

Power consumption*5

In [Standard] mode

FW-100BZ40J: 215 W

FW-75BZ30J: 187 W

FW-65BZ30J: 145 W

FW-55BZ30J: 123 W

FW-50BZ35J: 95 W

FW-50BZ30J: 97 W

FW-43BZ35J: 76 W

FW-43BZ30J: 64 W

FW-32BZ30J: 54 W

Annual energy consumption*5*6

FW-100BZ40J: 298 kWh per year

FW-75BZ30J: 259 kWh per year

FW-65BZ30J: 201 kWh per year

FW-55BZ30J: 171 kWh per year

FW-50BZ35J: 132 kWh per year

FW-50BZ30J: 135 kWh per year

FW-43BZ35J: 105 kWh per year

FW-43BZ30J: 89 kWh per year

FW-32BZ30J: 75 kWh per year

Standby power consumption*5*7*8

FW-100BZ40J / 75BZ30J / 65BZ30J / 55BZ30J / 50BZ35J / 50BZ30J / 43BZ35J / 43BZ30J:

0.50 W (25 W in software/EPG update mode)

FW-32BZ30J: 0.50 W (10 W in software/EPG update mode)

Display resolution (horizontal × vertical) (pixels)

3840 × 2160

Output Rating

500 mA (for USB 1), 900 mA (for USB 2)

Dimensions (Approx.) (w × h × d) (cm)

with Table-Top Stand

Standard position:

FW-100BZ40J: 226.0 × 134.6 × 47.5

FW-75BZ30J: 168.6 × 104.5 × 41.0

FW-65BZ30J: 146.2 × 91.2 × 33.8

FW-55BZ30J: 124.3 × 78.7 × 33.8

FW-50BZ35J: 111.9 × 71.5 × 28.6

FW-50BZ30J: 112.6 × 71.8 × 28.6

FW-43BZ35J: 96.4 × 62.8 × 28.6

FW-43BZ30J: 97.2 × 63.2 × 28.6

FW-32BZ30J: 72.6 × 45.4 × 17.2

Narrow position:

FW-75BZ30J: 168.6 × 104.5 × 41.0

FW-65BZ30J: 146.2 × 91.2 × 33.8

FW-55BZ30J: 124.3 × 78.7 × 33.8

without Table-Top Stand

FW-100BZ40J: 226.0 × 129.7 × 9.8

FW-75BZ30J: 168.6 × 96.9 × 7.2

FW-65BZ30J: 146.2 × 84.2 × 7.1

FW-55BZ30J: 124.3 × 71.9 × 7.1

FW-50BZ35J: 111.9 × 64.9 × 7.0

FW-50BZ30J: 112.6 × 65.3 × 7.0

FW-43BZ35J: 96.4 × 56.3 × 6.9

FW-43BZ30J: 97.2 × 56.7 × 7.0

FW-32BZ30J: 72.6 × 43.0 × 7.6

Stand width (Approx.) (cm)

Standard position:

FW-100BZ40J: 190.1

FW-75BZ30J: 133.0

FW-65BZ30J: 113.0

FW-55BZ30J: 98.3

FW-50BZ35J: 66.5

FW-50BZ30J: 66.5

FW-43BZ35J: 66.5

FW-43BZ30J: 66.5

FW-32BZ30J: 60.6

Narrow position:

FW-75BZ30J: 55.9

FW-65BZ30J: 47.8

FW-55BZ30J: 45.8

Mass (Approx.) (kg)

with Table-Top Stand

FW-100BZ40J: 92.6

FW-75BZ30J: 32.9

FW-65BZ30J: 22.5

FW-55BZ30J: 16.6

FW-50BZ35J: 13.3

FW-50BZ30J: 12.9

FW-43BZ35J: 10.7

FW-43BZ30J: 10.5

FW-32BZ30J: 7.7

without Table-Top Stand

FW-100BZ40J: 88.9

FW-75BZ30J: 31.6

FW-65BZ30J: 21.6

FW-55BZ30J: 15.7

FW-50BZ35J: 12.7

FW-50BZ30J: 12.3

FW-43BZ35J: 10.2

FW-43BZ30J: 10

FW-32BZ30J: 7.5

Others

Optional accessories

Wall-Mount Bracket: SU-WL850 (FW-75BZ30J / 65BZ30J / 55BZ30J only)

Wall-Mount Bracket: SU-WL450 (Except FW-100BZ40J)

Camera and Microphone Unit: FWA-CE100

Operating temperature: 0 °C – 40 °C

Operating humidity: 10 % – 80 % RH
(non-condensing)

- *1 When 4096 × 2160p is input and [Wide mode] is set to [Normal], the resolution is displayed as 3840 × 2160p. To display 4096 × 2160p, set [Wide mode] setting to [Full 1] or [Full 2].
- *2 Refer to the on screen menu to set [HDMI signal format].
- *3 HDMI IN 3 & 4 only. Use the Ultra High Speed HDMI Cable to connect.
- *4 Connect your audio system to the HDMI IN 3 to route LCD Monitor audio to your audio system.
- *5 This information is for EU and other countries whose relevant regulation is based on EU energy labelling regulation.
- *6 Energy consumption in kWh per year, based on the power consumption of the LCD Monitor operating 4 hours per day for 365 days. The actual energy consumption will depend on how the LCD Monitor is used.
- *7 Specified standby power is reached after the LCD Monitor finishes necessary internal processes.
- *8 Standby power consumption will increase when your LCD Monitor is connected to the network.

Note

- Optional accessories availability depends on countries/region/LCD Monitor model/stock.
- Design and specifications are subject to change without notice.
- Some of the on-screen instructions may not apply to your LCD Monitor model.
- Product fiche in this manual is for COMMISSION DELEGATED REGULATION (EU) 1062/2010. Refer to its website for (EU) 2019/2013 information.

Trademark Information

- The terms HDMI, HDMI High-Definition Multimedia Interface, and the HDMI Logo are trademarks or registered trademarks of HDMI Licensing Administrator, Inc.
- Dolby, Dolby Vision, Dolby Atmos, Dolby Audio, and the double-D symbol are trademarks of Dolby Laboratories Licensing Corporation. Manufactured under license from Dolby Laboratories. Confidential unpublished works. Copyright © 1992-2020 Dolby Laboratories. All rights reserved.
- Vewd® Core. Copyright 1995-2021 Vewd Software AS. All rights reserved.
- Google and Android are trademarks of Google LLC.
- Wi-Fi®, Wi-Fi Alliance® and Wi-Fi Direct® are registered trademarks of Wi-Fi Alliance.
- The Wi-Fi CERTIFIED™ Logo is a certification mark of Wi-Fi Alliance.

- For DTS patents, see <http://patents.dts.com>. Manufactured under license from DTS, Inc. DTS, Digital Surround, and the DTS logo are registered trademarks or trademarks of DTS, Inc. in the United States and other countries. © 2020 DTS, Inc. ALL RIGHTS RESERVED.
- The Bluetooth® word mark and logos are registered trademarks owned by the Bluetooth SIG, Inc. and any use of such marks by Sony Corporation is under license. Other trademarks and trade names are those of their respective owners.
- TUXERA is a registered trademark of Tuxera Inc. in the US and other countries.
- All other trademarks are the property of their respective owners.

Product registration number (COMMISSION DELEGATED REGULATION (EU) 2019/2013)

FW-100BZ40J (495597), FW-75BZ30J (527375),
FW-65BZ30J (527373), FW-55BZ30J (527370),
FW-50BZ35J (526764), FW-50BZ30J (527368),
FW-43BZ35J (526771), FW-43BZ30J (527366),
FW-32BZ30J (527365).