

marantz

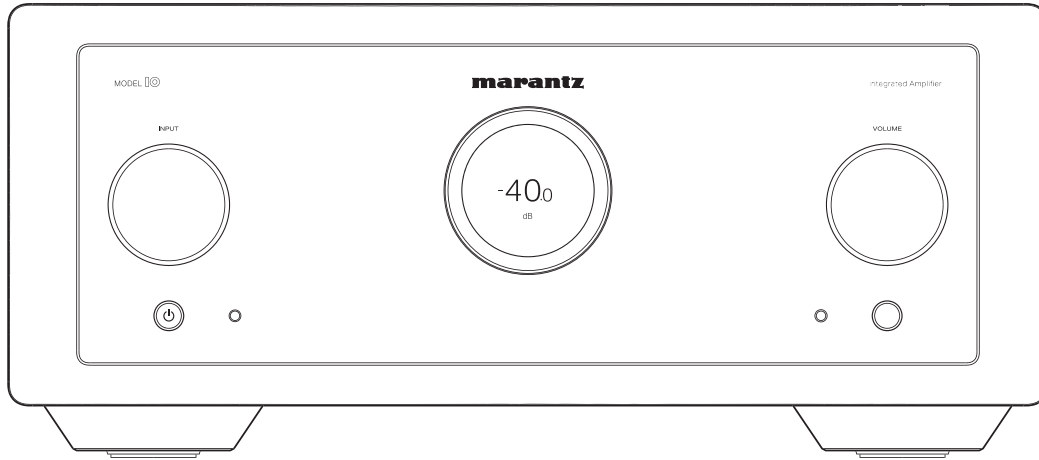

MODEL 10 | Integrated Amplifier

Owner's Manual

Accessories	4
Inserting the batteries	5
Operating range of the remote control unit	5
Part names and functions	6
Front/Top panel	6
Rear panel	9
Remote control unit	11

Connections

Connecting speakers	17
Speaker A/B connection	19
Bi-wiring connection	20
Connecting a playback device	21
Connecting a recording device	23
Connecting a pre-amplifier or power amplifier	24
Connecting multiple MODEL 10 units (F.C.B.S. connection)	26
Preparation for F.C.B.S. connection	26
Stereo complete bi-amp connection	29
Connection for 5.1 Multi-channel Playback	31
Connecting an external control device	35
FLASHER IR IN jack	35
REMOTE CONTROL connectors	36
Connecting the power cord	38

Playback

Turning the power on	40
Switching the power to standby	40
Selecting the input source	41
Adjusting the volume	41
Turning off the sound temporarily (Muting)	41
Adjusting the tone and balance	42
Playback in source direct mode	44
Switching the display's brightness	44
Turning the front panel illumination, interior illumination and display on/off	45
Using this unit as a power amplifier	45
Recording	46



Settings

Menu map	47
Menu operation	48
Level Meter	49
Illumination	49
Volume Scale	50
Phono	50
Auto-Standby	51
Setting remote control codes	52
Setting remote control codes for the remote control	53
Setting remote control codes for the main unit	53
Disabling SACD player/streaming preamplifier operating mode on remote control	54
Disabling SACD player operating mode	55
Disabling streaming preamplifier operating mode	55
Setting the device to be operated by the volume buttons on the remote control	56
Setting the device to be operated by the volume buttons in SACD player operating mode	57
Setting the device to be operated by the volume buttons in streaming preamplifier operating mode	57

Tips

Tips	59
Troubleshooting	60
Power does not turn on / Power is turned off	61
Operations cannot be performed through the remote control unit	63
Display on this unit shows nothing	64
No sound comes out	64
Desired sound does not come out	65
Sound is interrupted or noise occurs	66
Error messages	67

Appendix

Explanation of terms	68
Specifications	69
Index	72







Thank you for purchasing this Marantz product.

To ensure proper operation, please read this owner's manual carefully before using the product.

After reading this manual, be sure to keep it for future reference.

Accessories

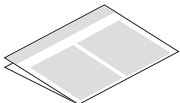
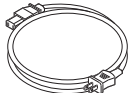
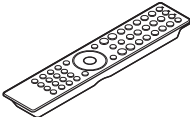
Check that the following parts are included with the product.

 <p>Quick Start Guide</p>	 <p>Safety Instructions</p>	 <p>Warranty (for North America model only)</p>	 <p>Power cord</p>
 <p>Remote control unit (RC004PMND)</p>	 <p>2× R03/AAA batteries</p>		



Inserting the batteries

- 1 Remove the rear lid in the direction of the arrow and remove it.

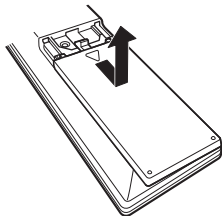

- 2 Insert two batteries correctly into the battery compartment as indicated.

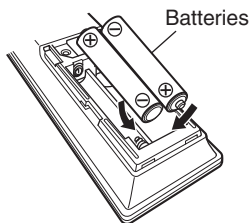

- 3 Put the rear lid back on.

NOTE

- To prevent damage or leakage of battery fluid:
 - Do not use a new battery together with an old one.
 - Do not use two different types of batteries.
- Remove the batteries from the remote control unit if it will not be in use for long periods.
- If the battery fluid should leak, carefully wipe the fluid off the inside of the battery compartment and insert new batteries.

Operating range of the remote control unit

Point the remote control unit at the remote sensor when operating it.

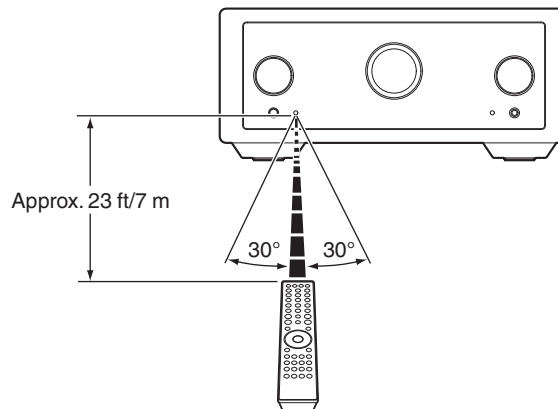

Part names and functions

Front/Top panel

[Top panel]

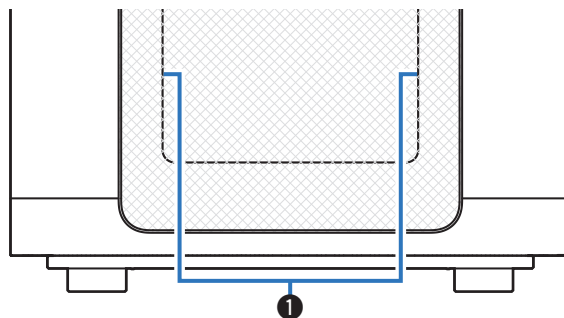

[Front panel]

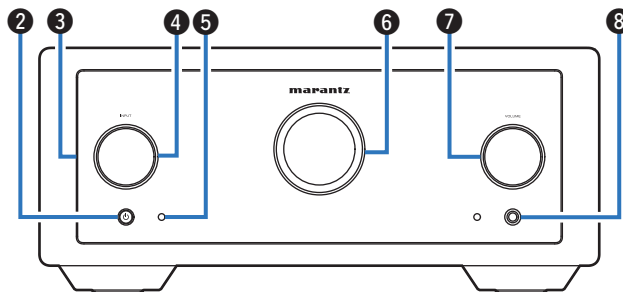

For details, see the next page.

【Top panel】

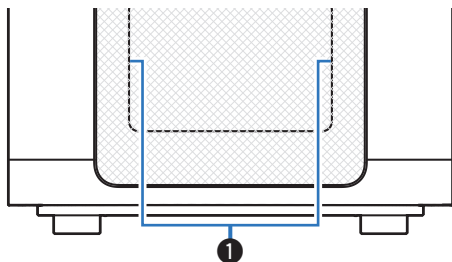

【Front panel】

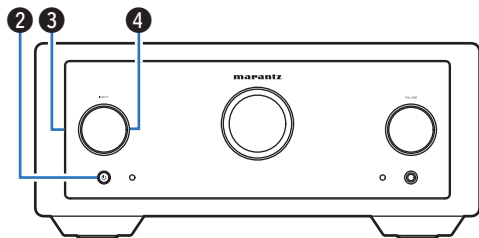
**1 Interior illumination**

Illuminates when powered on. Brightness can be changed and lighting turned off.

- “Turning the front panel illumination, interior illumination and display on/off” (☞ p. 45)
- “Illumination” (☞ p. 49)

2 Power (⏻) button/indicator

- This turns the power on/off (standby). (☞ p. 40)
- This is lit as follows according to the power status:
 - Power on : White
 - Standby : Off
 - When the protection circuit is activated : Orange (blinking)

3 Front panel illumination

Illuminates when powered on. Brightness can be changed and lighting turned off.

- “Turning the front panel illumination, interior illumination and display on/off” (☞ p. 45)
- “Illumination” (☞ p. 49)

4 INPUT selector knob

This selects the input source. (☞ p. 41)

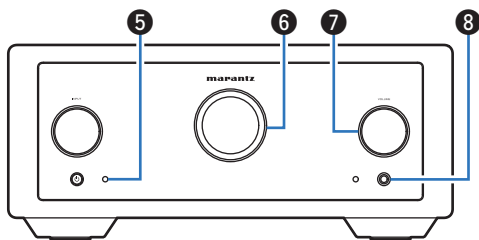

【Front panel】

**5 Remote control sensor**

This receives signals from the remote control unit. (☞ p. 5)

6 Display

This displays various pieces of information.

7 VOLUME knob

Adjusts the volume level. (☞ p. 41)

8 Headphones jack

Used to connect headphones.

When the headphones are plugged into this jack, audio will no longer be output from the connected speakers and from the PREAMP OUT connectors.

NOTE

- To prevent hearing loss, do not raise the volume level excessively when using headphones.



Rear panel

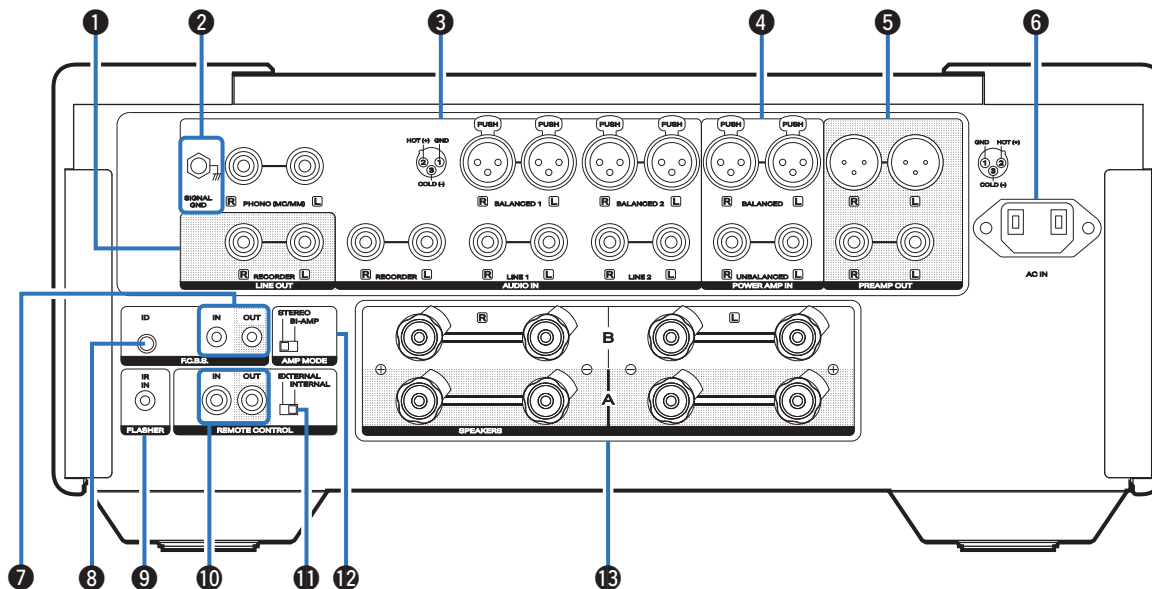

For details, see the next page.



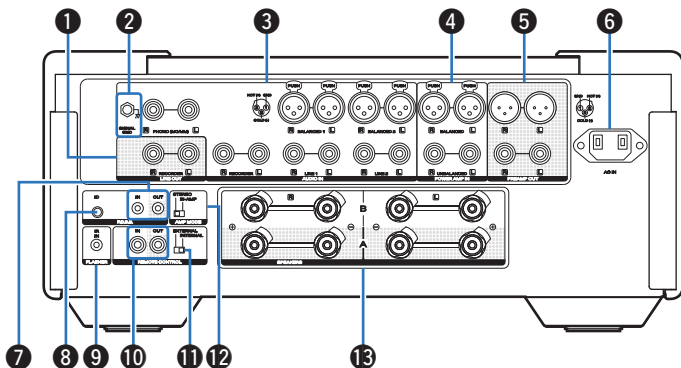

1 LINE OUT connectors (RECORDER)

Used to connect the input connector of a recorder. (☞ p. 23)

2 SIGNAL GND terminal

Used to connect a turntable. (☞ p. 21)

3 Analog audio input connectors (AUDIO IN)

Used to connect devices equipped with analog audio output connectors.

- “Connecting a playback device” (☞ p. 21)
- “Connecting a recording device” (☞ p. 23)

4 Power amplifier connectors (POWER AMP IN)

Used to connect a pre-amplifier when this unit is used as a power amplifier. (☞ p. 24)

5 PREAMP OUT connectors

Use this to add such equipment as a power amplifier. (☞ p. 24)

6 AC inlet (AC IN)

Used to connect the power cord. (☞ p. 38)

7 F.C.B.S. connectors

Used to connect a high quality playback system using two or more of these units. (☞ p. 26)

8 F.C.B.S. ID button

Used to set the ID for F.C.B.S.. (☞ p. 28)

9 FLASHER IR IN jack

Used to connect a control box, etc. (☞ p. 35)

10 Remote control input/output connectors (REMOTE CONTROL)

Used to connect to a Marantz audio device that is compatible with the remote control function. (☞ p. 36)

11 EXTERNAL/INTERNAL switch

Turn this switch to "INTERNAL", this unit receives the remote control signal and the Marantz audio device connected to this unit using the remote control connection operates by receiving the remote control signal from this unit. (☞ p. 37)

12 AMP MODE switch

Used to switch the amplifier mode (STEREO/BI-AMP). (☞ p. 29)

13 Speaker terminals (SPEAKERS)

Used to connect speakers. (☞ p. 17)



Remote control unit

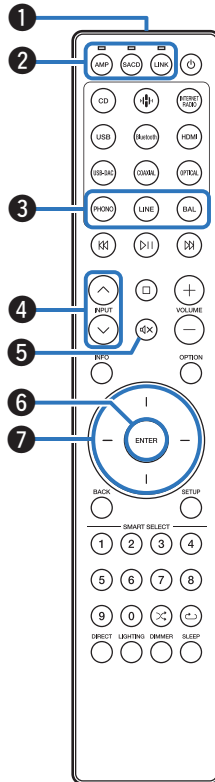

The remote control provided with this unit can control a Marantz SACD player and streaming preamplifier.

- “SACD player operations” (☞ p. 13)
- “Streaming preamplifier operations” (☞ p. 14)

■ Operating this unit

To operate this unit, press AMP button to switch the remote control operating mode to this unit.

1 Remote control signal transmitter

This transmits signals from the remote control unit. (☞ p. 5)

2 Remote mode select buttons/indicators (AMP/SACD/LINK)

- These switch the remote control operating mode (AMP/SACD/LINK).
- The indicator will light up according to the device being operated.

3 Input source select buttons (PHONO/LINE/BAL)

This selects the input source. (☞ p. 41)

4 INPUT buttons (▲▼)

This selects the input source. (☞ p. 41)

5 Mute button (MUTE)

This mutes the output audio. (☞ p. 41)

6 ENTER button

This determines the selection.

7 Cursor buttons

These select items.



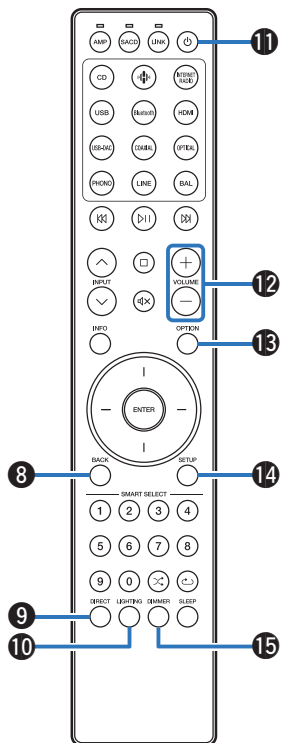

8 BACK button

Returns to the previous item.

9 DIRECT button

This turns source direct mode on/off. (👉 p. 44)

10 LIGHTING button

This turns the front panel illumination, interior illumination and display on/off. (👉 p. 45)

11 Power (⏻) button

This turns the power on/off (standby). (👉 p. 40)

12 VOLUME buttons (+/-)

These adjust the volume level. (👉 p. 41)

13 OPTION button

This displays the option menu on the display.

- “Adjusting the tone and balance” (👉 p. 42)



- An option menu is not displayed when the input sources are “Power Amp Balanced” and “Power Amp Unbalanced”.

14 SETUP button

The setting menu is displayed on the display. (👉 p. 48)

15 DIMMER button

Adjust the display brightness of this unit. (👉 p. 44)



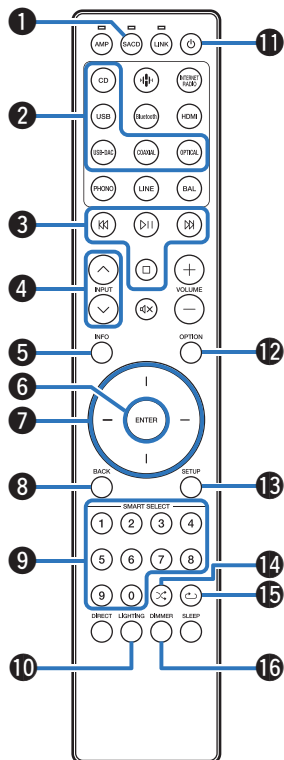

■ SACD player operations

A Marantz SACD player can be operated.

To operate SACD player, press SACD button to switch the remote control to the SACD player operation mode.

- 1 Remote mode select button (SACD)
- 2 Input source select buttons
- 3 System buttons
- 4 INPUT buttons (^v)
- 5 Information button (INFO)
- 6 ENTER button
- 7 Cursor buttons
- 8 BACK button
- 9 Number buttons (0 – 9)
- 10 LIGHTING button
- 11 Power (⏻) button
- 12 OPTION button
- 13 SETUP button
- 14 Random button (⌘)
- 15 Repeat button (↺)
- 16 DIMMER button



- The remote control may not operate some products.



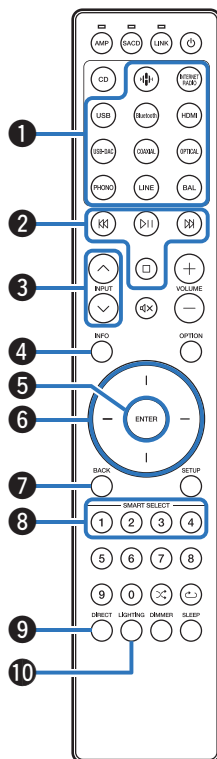

■ Streaming preamplifier operations

A Marantz streaming preamplifier can be operated.

To operate streaming preamplifier, press LINK button to switch the remote control to the streaming preamplifier operation mode.

- 1 Input source select buttons
- 2 System buttons
- 3 INPUT buttons (^∨)
- 4 Information button (INFO)
- 5 ENTER button
- 6 Cursor buttons
- 7 BACK button
- 8 SMART SELECT 1 - 4 buttons
- 9 DIRECT button
- 10 LIGHTING button



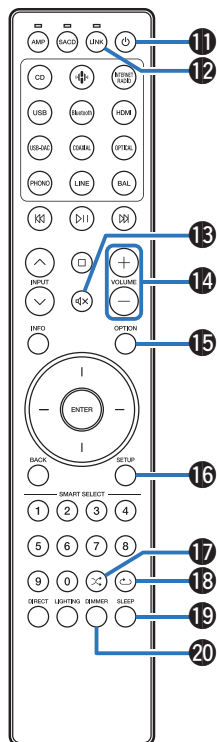

- ① Power (⏻) button
- ② Remote mode select button (LINK)
- ③ Mute button (⏸)
- ④ VOLUME buttons (+/-)
- ⑤ OPTION button
- ⑥ SETUP button
- ⑦ Random button (⌘)
- ⑧ Repeat button (↺)
- ⑨ SLEEP button
- ⑩ DIMMER button



- The remote control may not operate some products.



■ Contents

Connecting speakers	17
Connecting a playback device	21
Connecting a recording device	23
Connecting a pre-amplifier or power amplifier	24
Connecting multiple MODEL 10 units (F.C.B.S. connection)	26
Connecting an external control device	35
Connecting the power cord	38

NOTE

- Do not plug in the power cord until all connections have been completed.
- Do not bundle power cords together with connection cables. Doing so can result in humming or noise.

■ Cables used for connections

Provide necessary cables according to the devices you want to connect.

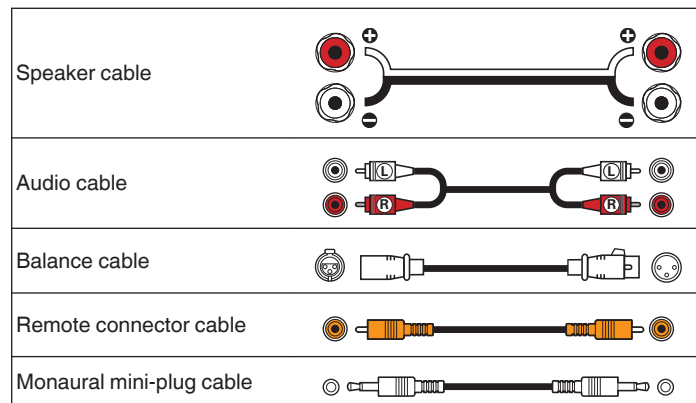

Connecting speakers

NOTE

- Disconnect this unit's power plug from the power outlet before connecting the speakers.
- Connect so that the speaker cable core wires do not protrude from the speaker terminal. The protection circuit may be activated if the core wires touch the rear panel or if the + and - sides touch each other. ("Protection circuit" (👉 p. 68))
- Never touch the speaker terminals while the power cord is connected. Doing so could result in electric shock.
- Use speakers with impedances within the ranges shown below to suit how they are used.

Speaker terminals used on this unit	No. of connected speakers	Speaker Impedance
SPEAKERS A (Standard connection)	2 (one set)	4 – 16 Ω/ohms
SPEAKERS B	2 (one set)	4 – 16 Ω/ohms
SPEAKERS A and SPEAKERS B	4 (two sets)	8 – 16 Ω/ohms
SPEAKERS A and SPEAKERS B (Bi-wiring connection)	2 (one set)	4 – 16 Ω/ohms

■ Connecting the speaker cables

Carefully check the left (L) and right (R) channels and + (red) and - (white) polarities on the speakers being connected to this unit, and be sure to connect the channels and polarities correctly.

- 1 Peel off about 3/8 inch (10 mm) of sheathing from the tip of the speaker cable, then either twist the core wire tightly or terminate it.**



- 2 Turn the speaker terminal counterclockwise to loosen it.**

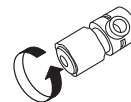

- 3 Insert the speaker cable's core wire to the hilt into the speaker terminal.**

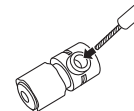

4 Turn the speaker terminal clockwise to tighten it.

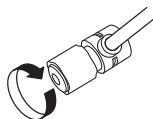

Spade lug connector



When using a banana plug

Tighten the speaker terminal firmly before inserting the banana plug.

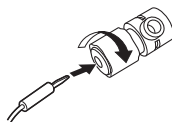

Speaker A/B connection

This unit is equipped with two sets of speaker terminals (SPEAKER A and SPEAKER B). One set of speakers can be connected to each set of terminals, and a total of two sets of speakers can be connected.

The same signal is output from the SPEAKERS A and SPEAKERS B terminals.

When only one set of speakers is to be connected, use either the SPEAKERS A or SPEAKERS B terminals.

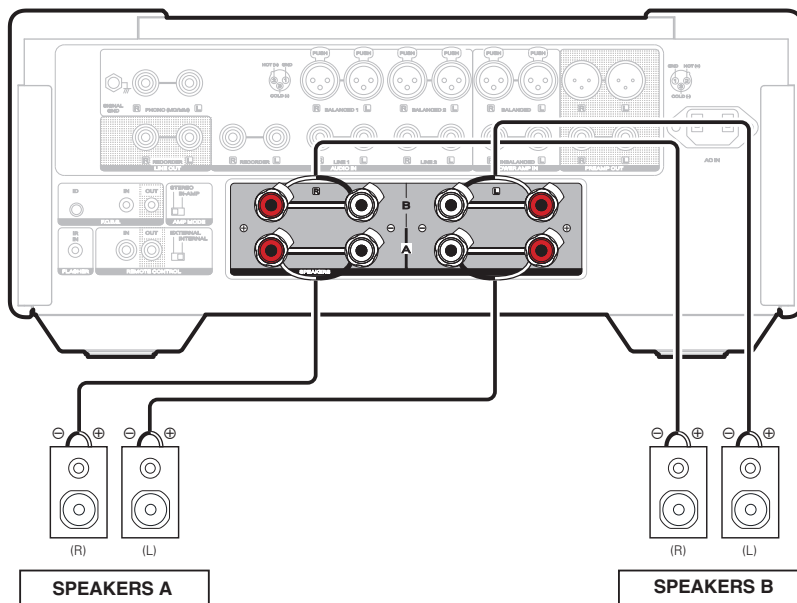

Bi-wiring connection

This connection limits the effects of signal interference between the high range speakers (tweeters) and low range speakers (woofers), allowing you to enjoy high quality playback.

When bi-wiring with bi-wireable speakers, connect the mid and high range terminals to SPEAKERS B (or SPEAKERS A), the low range terminals to SPEAKERS A (or SPEAKERS B).

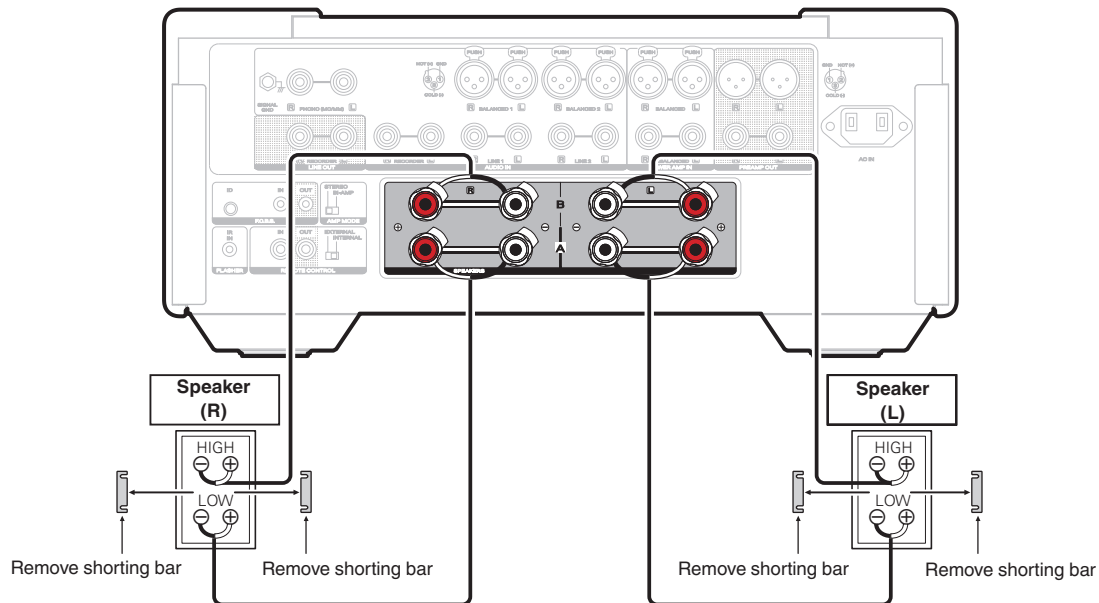

Connecting a playback device

You can connect turntables, network audio players and CD players to this unit. Set the phono equalizer of this unit in the “Phono” section of the setting menu according to the type of turntable cartridge to be connected. (🔗 p. 50)

If you set this unit’s input source to “Phono” and you accidentally increase the volume without having a turntable connected, you may hear a hum noise from the speakers.

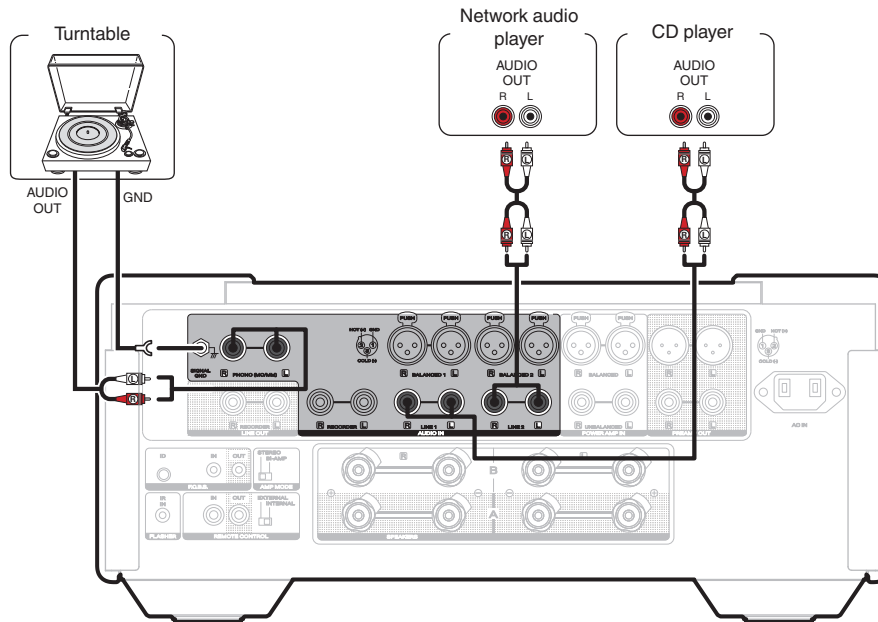

NOTE

- The earth terminal (SIGNAL GND) of this unit is not for safety grounding purposes. If this terminal is connected when there is a lot of noise, the noise can be reduced. Note that depending on the turntable, connecting the ground line may have the reverse effect of increasing noise. In this case, it is not necessary to connect the ground line.



- The PHONO input terminals are equipped with a short-circuiting pin plug. Remove this plug to connect a record player. Store the removed short-circuiting pin plug in a safe place so as not to lose it.



■ About balanced connectors

This unit has both unbalanced and balanced connectors. The balanced connectors have three pins, making it possible to transmit audio signals as a balanced signal, reducing the effect of external noise. They also have a removable lock mechanism, which reduces shaking in the connector area, making the connection highly reliable.



- The balanced connection is an all-stage balanced configuration.

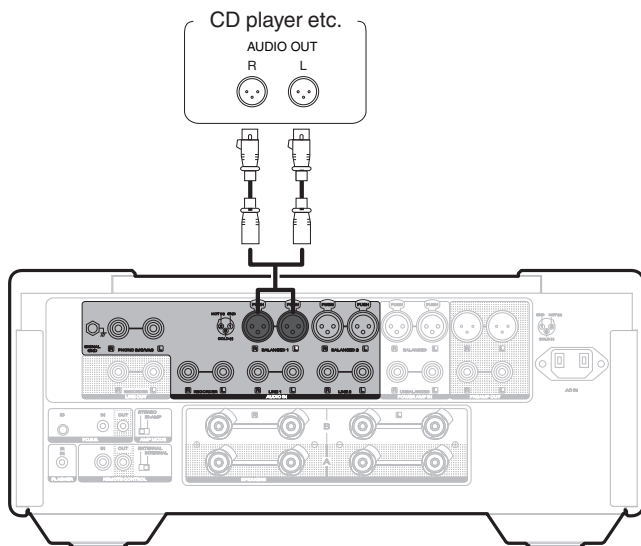

■ Phases of the balanced connectors

The XLR connector is internally wired in either of the following two systems. This unit employs the European system.

- European system (② PIN=HOT / ③ PIN=COLD)

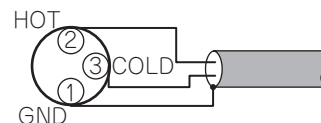

- USA system (② PIN=COLD / ③ PIN=HOT)

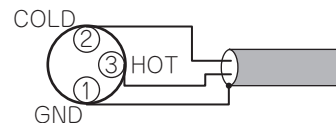

If a product that employs the USA system is connected with this unit via a balanced cable, the output signal may be phase-inverted. To correct the inversion, connect the one side XLR connector reversing the ② PIN and ③ PIN.



Connecting a recording device

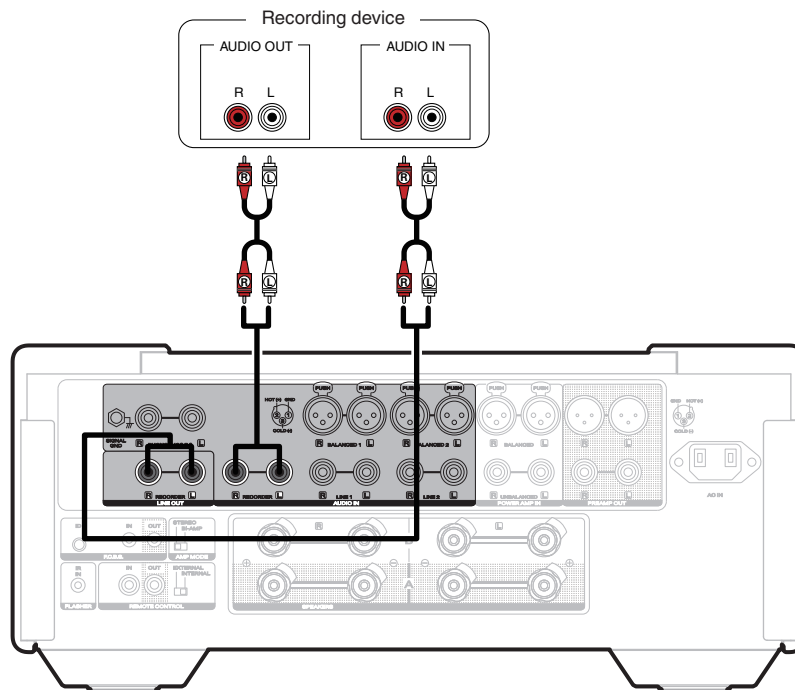

NOTE

- Never insert the short-circuiting pin plug into the recording output connectors (LINE OUT RECORDER). Doing so could result in damage.



Connecting a pre-amplifier or power amplifier

Connect a power amplifier to the unit to use it as a pre-amplifier, or connect a pre-amplifier to the unit to use it as a power amplifier.

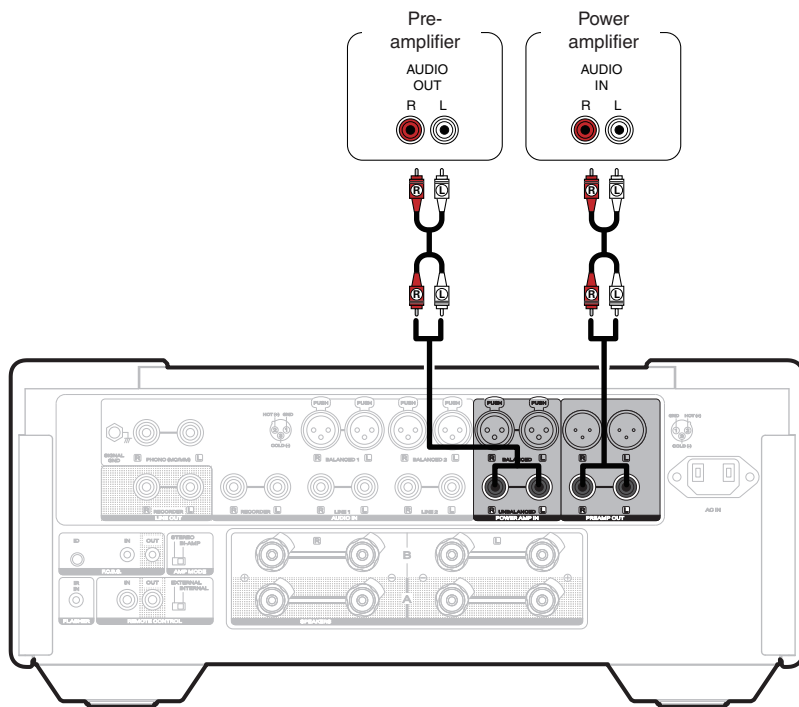

- When connecting a pre-amplifier and using this unit as a power amplifier, switch the input source to “Power Amp Balanced” or “Power Amp Unbalanced”. (p. 45)
- The POWER AMP IN (UNBALANCED) connectors are equipped with a short-circuiting pin plug. Remove this plug to connect a pre-amplifier. Store the removed short-circuiting pin plug in a safe place so as not to lose it.

NOTE

- Never insert the short-circuiting pin plug into the PREAMP OUT connectors. Doing so could result in damage.



■ About balanced connectors

This unit has both unbalanced and balanced connectors. The balanced connectors have three pins, making it possible to transmit audio signals as a balanced signal, reducing the effect of external noise. They also have a removable lock mechanism, which reduces shaking in the connector area, making the connection highly reliable.



- The balanced connection is an all-stage balanced configuration.

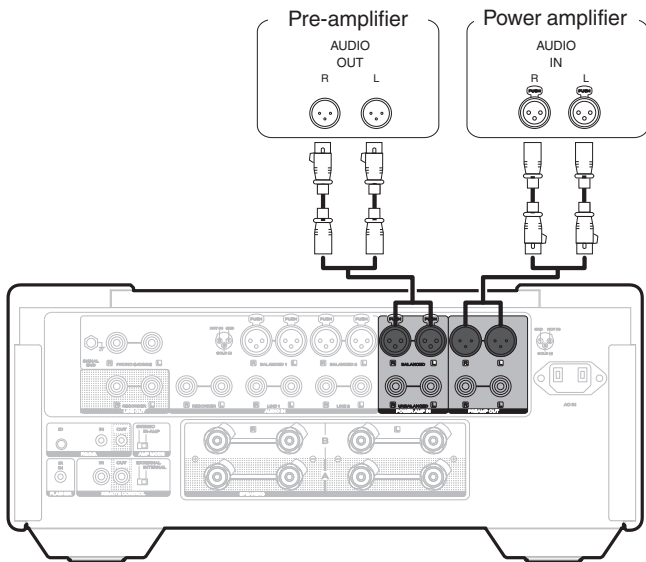

■ Phases of the balanced connectors

The XLR connector is internally wired in either of the following two systems. This unit employs the European system.

- European system (② PIN=HOT / ③ PIN=COLD)

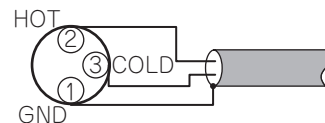

- USA system (② PIN=COLD / ③ PIN=HOT)

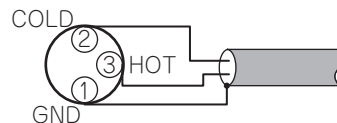

If a product that employs the USA system is connected with this unit via a balanced cable, the output signal may be phase-inverted. To correct the inversion, connect the one side XLR connector reversing the ② PIN and ③ PIN.



Connecting multiple MODEL 10 units (F.C.B.S. connection)

The Marantz F.C.B.S. (Floating Control Bus System) is the high quality sound system for link control between multiple MODEL 10 units (up to 4 units). Each unit is controlled via its ID registered beforehand. The IDs need to be set to an operating unit (Leader) and a subordinate unit (Member 1 - 3) receiving the command from the leader. For member units, register Member 1 - 3 in the order of command reception from the leader. IDs can be set for units connected by F.C.B.S. to perform linked operations such as switching the input source, adjusting the volume, muting, adjusting the volume balance, adjusting the sound quality and trimming the display brightness. Furthermore, F.C.B.S. connection of multiple MODEL 10 units has the feature that switches this unit's output from stereo to monaural so that the unit can work as a monaural output amplifier. Follow the respective instructions to make the necessary settings.

Preparation for F.C.B.S. connection

■ Making the F.C.B.S. connection

To use multiple MODEL 10 units, make this connection in addition to audio connection. For details on each connection feature, refer to the respective instructions.

- "Stereo complete bi-amp connection" (👉 p. 29)
- "Connection for 5.1 Multi-channel Playback" (👉 p. 31)

Prepare the correct number of portable audio connection cables for the number of units to be connected. Either of the following types of connection cables are adequate.

- $\Phi 3.5$ Monaural mini plug \leftrightarrow $\Phi 3.5$ monaural mini plug connecting cable

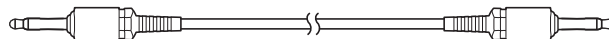

- $\Phi 3.5$ Stereo mini plug \leftrightarrow $\Phi 3.5$ stereo mini plug connecting cable

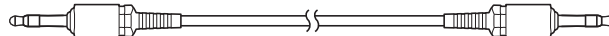

NOTE

- Do not use connecting cables that contain resistance.



■ Connection example

In this example, the unit with ID set to “Leader” controls the units with the IDs set to “Member 1”, “Member 2”, or “Member 3”.



- The MODEL 10 F.C.B.S. function is only valid between the same MODEL 10 models.
- If you want to power on multiple amplifiers connected to the F.C.B.S., please turn on the power in the order of “Leader” - “Member 1” - “Member 2” - “Member 3”. When turning off the power, turn them off in the reverse order.

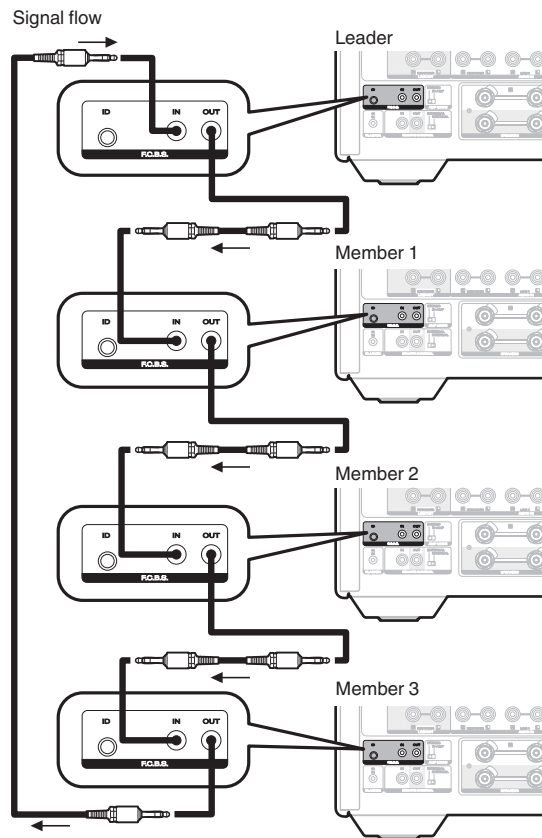

■ How to set ID for F.C.B.S.

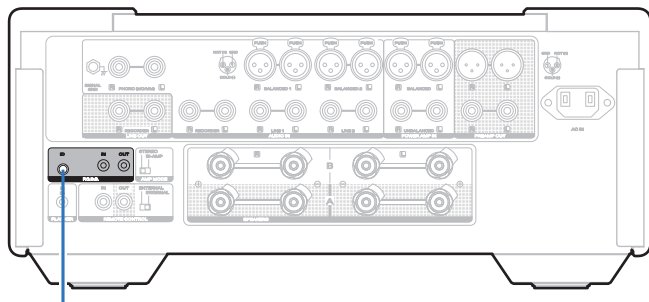

F.C.B.S. ID

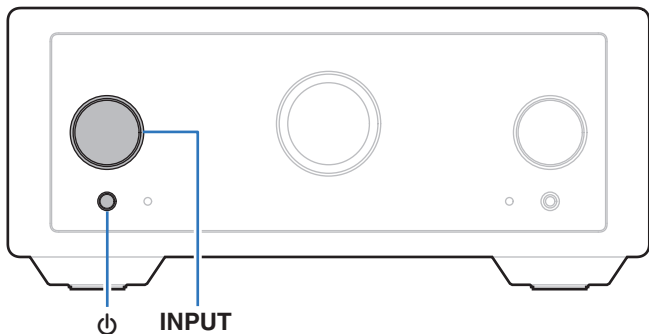

1 While holding F.C.B.S. ID on the rear panel, press .

2 Turn the INPUT knob on the main unit to select an ID.

- The IDs need to be set to an operating unit (Leader) and a subordinate unit (Member 1 - 3) receiving the command from the leader.

3 Press F.C.B.S. ID on the rear panel to confirm the selected ID.

After showing the ID on the display for about 3 seconds, the unit will automatically restart.

- If set to "Member 1", "Member 2" or "Member 3", the ID set on the normal screen is displayed.



- If using this unit by itself as a stereo amplifier, set the ID to "Off". (Default setting is "Off".)
- If the ID is set to other than "Off", this unit cannot be used for standalone operation.



Stereo complete bi-amp connection

This mode enables the two amplifiers connected to this unit to function as one monaural amplifier. To use this mode, two F.C.B.S. connected MODEL 10 units are required.

To switch the mode, use the AMP MODE switch on the rear panel while the power is off.

If this unit is set to the bi-amp mode, "BI-AMP" appears on the display.

In bi-amp mode, connect to the left channel input connector.

The right channel input is disabled.

The same signals are output from the left and right speaker terminals.



- Be sure to turn the power off before operating the AMP MODE switch. Settings can be configured when the power is turned on.
- When in bi-amp mode, the R channel input connectors cannot be used.
- When in bi-amp mode, the signals input into the L channel are output from both channels. Therefore, the same signals are output from the L channel and R channel in LINE OUT (RECORDER), PREAMP OUT, headphones jack.
- Speaker systems connected using complete bi-amp connections must support bi-amp connections. Before connecting your speakers, check in the instruction manual that came with the speakers or contact the manufacturer to confirm whether they support bi-amp connection.



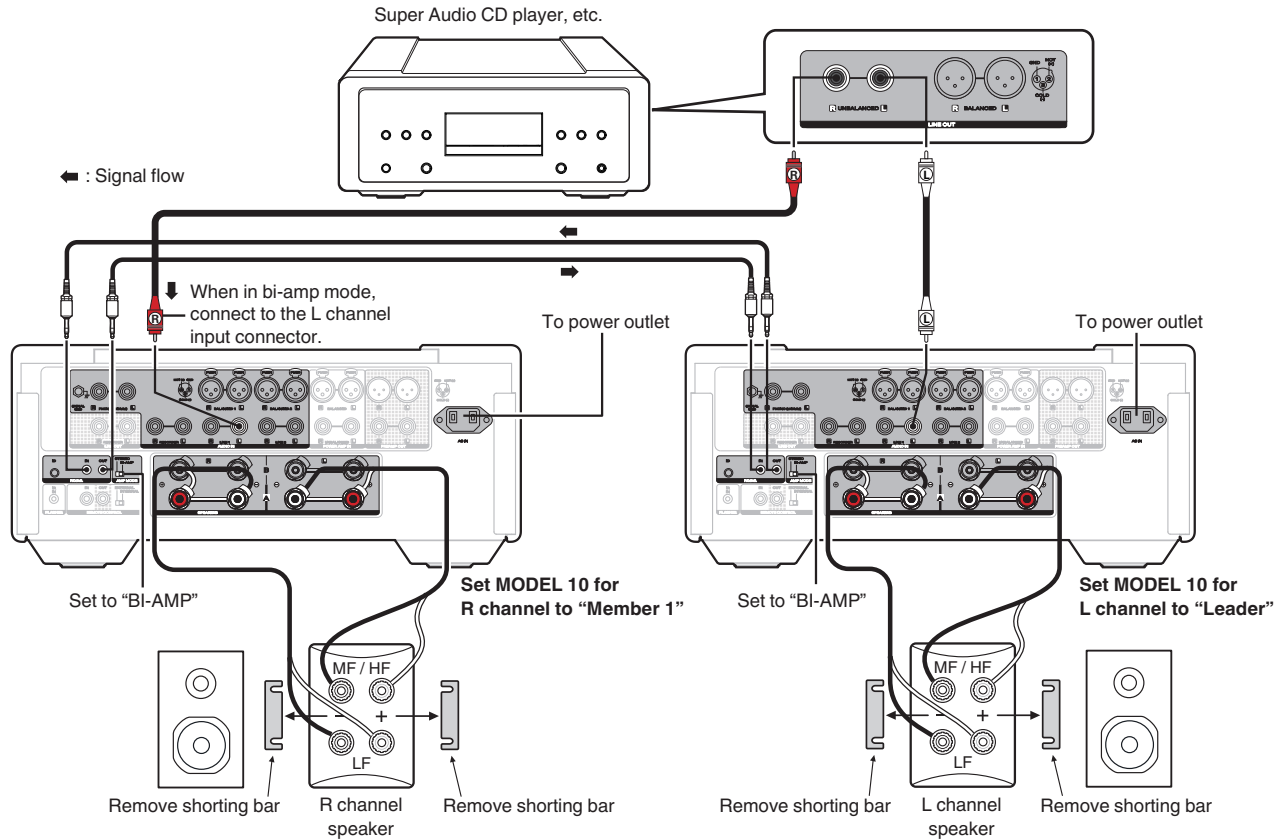

Connection for 5.1 Multi-channel Playback

Three MODEL 10 units can be connected by F.C.B.S. and used through linked operation. For details on F.C.B.S. connection, see “Connection example” (👉 p. 27).

Connect the outputs of players that have 5.1 channel analog outputs to each of the three units.

If using an active subwoofer, see the instruction manual that came with the subwoofer for further instructions.

Set the IDs for the three amplifiers as explained in How to set ID for F.C.B.S. (👉 p. 28)

- When you operate the unit with the ID set to “Leader”, the units set to “Member 1” and “Member 2” are linked.



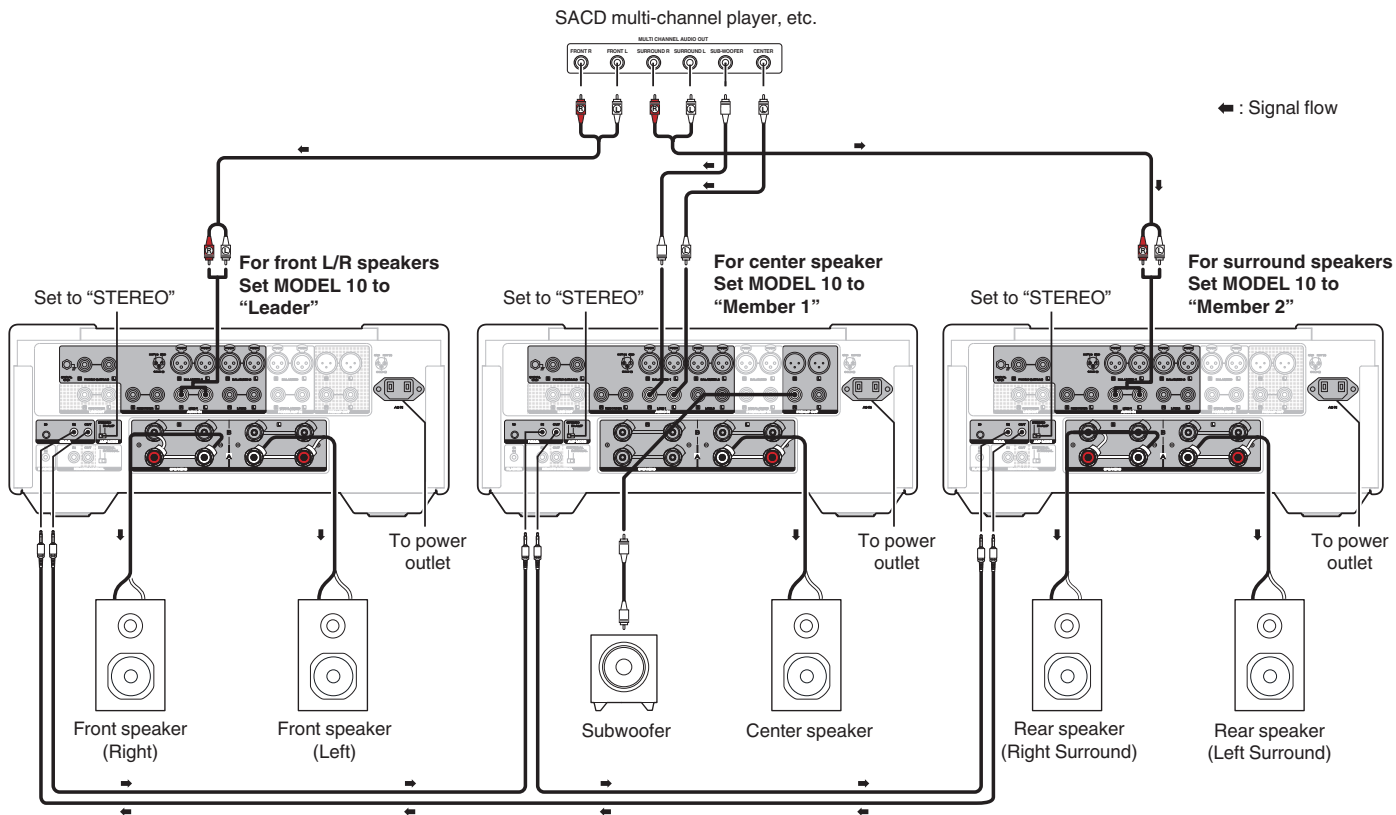

■ Speaker Positioning for Super Audio Multi-channel Sound

In order to enjoy Super Audio CD multi-channel sound with the best possible acoustics, it is recommended to position speakers as specified in ITU-R BS.775-1 of the International Telecommunication Union (ITU). Super Audio CD multichannel discs are recorded and mixed so as to achieve the optimum effect with a speaker system laid out as specified in ITU-R BS.775-1.

- With Super Audio CD multi-channel discs, the music signals are basically recorded using 5 channels (3 - 6 channels sometimes), but in some cases, LFE (for subwoofer) is recorded as a sixth channel.
- Each disc indicates how many channels have been recorded on it.
- The basic layout is 3 speakers in the front and 2 in the back since multi-channel discs usually have 5 channels. The 2 front, 1 center and 2 surround (rear) speakers should be set in a circle around the listening point. If using speakers of differing sizes, adjust volume balance from the amplifier.
- The location of the subwoofer in the figure is just for explanatory purposes. It can be located anywhere in the room. For connection and positioning instructions, see the instruction manual that came with the subwoofer.



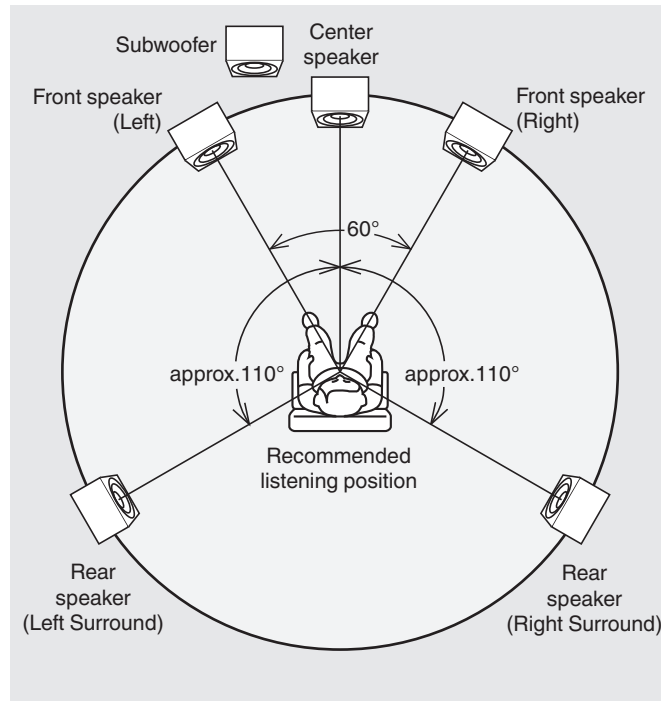

- ITU (International Telecommunication Union)

The ITU is a special organization of the United Nations. It consists of a number of organs, one of which is the Radio Broadcasting Section. ITU-R BS in the recommendation which consists of standards relating to broadcasting (audio) operations, one of which is the ITU-R BS.775-1 which governs “multi-channel stereo sound systems”.



Connecting an external control device

FLASHER IR IN jack

This unit can be controlled by connecting a control box or other control device to this unit.

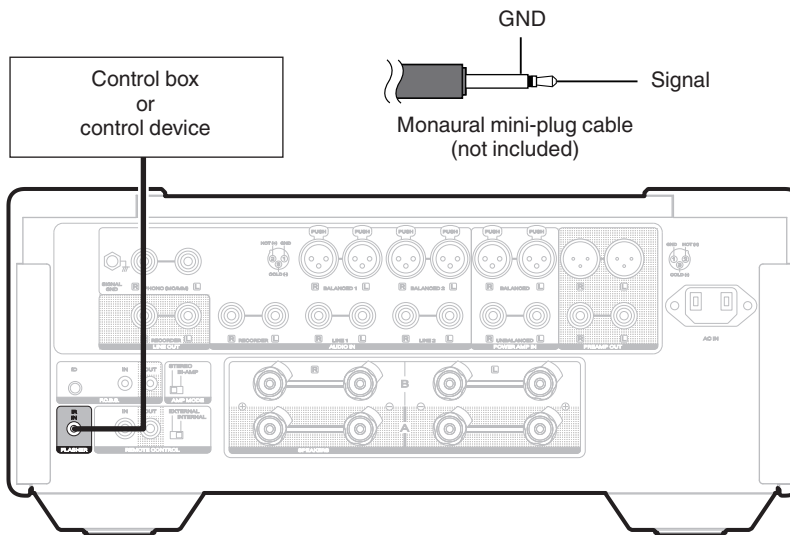

- To use the FLASHER IR IN jack, set the EXTERNAL/INTERNAL switch to “INTERNAL”.



REMOTE CONTROL connectors

■ Performing operations by RC on this unit without visual contact

You can connect an external IR receiver to the REMOTE CONTROL connectors to perform operations on this unit with the included remote control unit without visual contact. This might be necessary if the unit is hidden in a cupboard or corner, so you can't directly point with the remote control unit to the device.

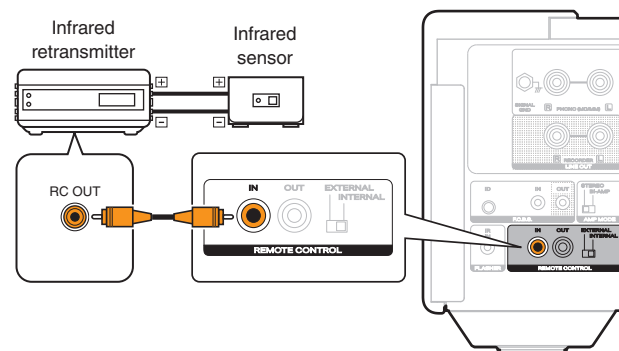

■ Remotely connecting Marantz LINK 10n and SACD 10

If you connect the unit to the REMOTE CONTROL IN/OUT connectors using the remote connection cable provided with the Marantz audio unit, you can turn on the power or the standby mode of the LINK 10n and SACD 10 in conjunction with the operation of the unit.

Set the EXTERNAL/INTERNAL switch on the rear panel of this unit and the connected device as follows.

- Turn this unit's EXTERNAL/INTERNAL switch to "INTERNAL".
- Turn the EXTERNAL/INTERNAL switch of the connected device to "EXTERNAL".

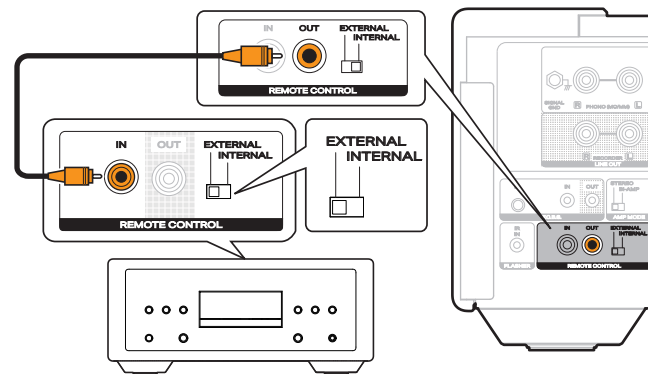

- To operate the unit, point the remote control at the remote sensor of this unit.
- To use this unit by itself without connecting a Marantz audio device, turn the switch to "INTERNAL".



Connecting the power cord

After completing all the connections, insert the power plug into the power outlet.

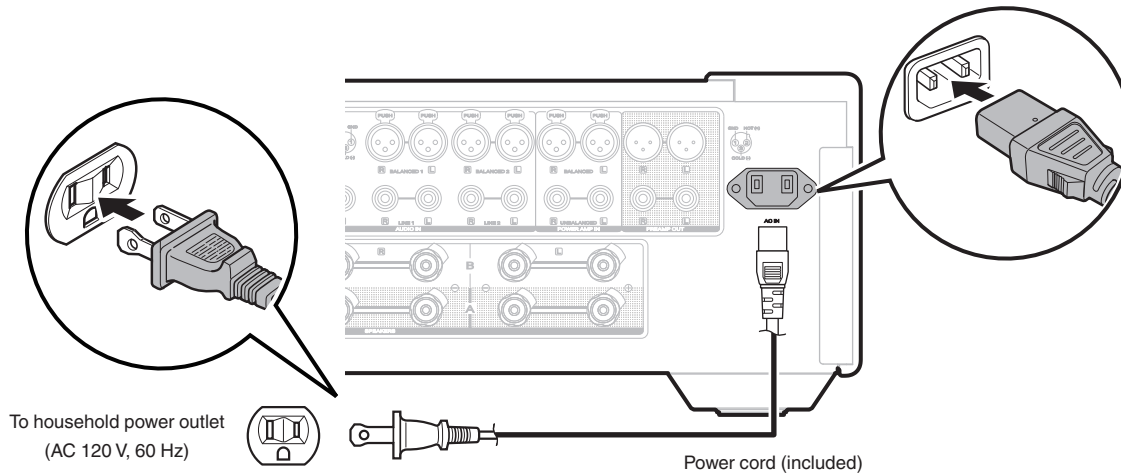

■ Contents

Turning the power on	40
Switching the power to standby	40
Selecting the input source	41
Adjusting the volume	41
Turning off the sound temporarily (Muting)	41
Adjusting the tone and balance	42
Playback in source direct mode	44
Switching the display's brightness	44
Turning the front panel illumination, interior illumination and display on/off	45
Using this unit as a power amplifier	45
Recording	46



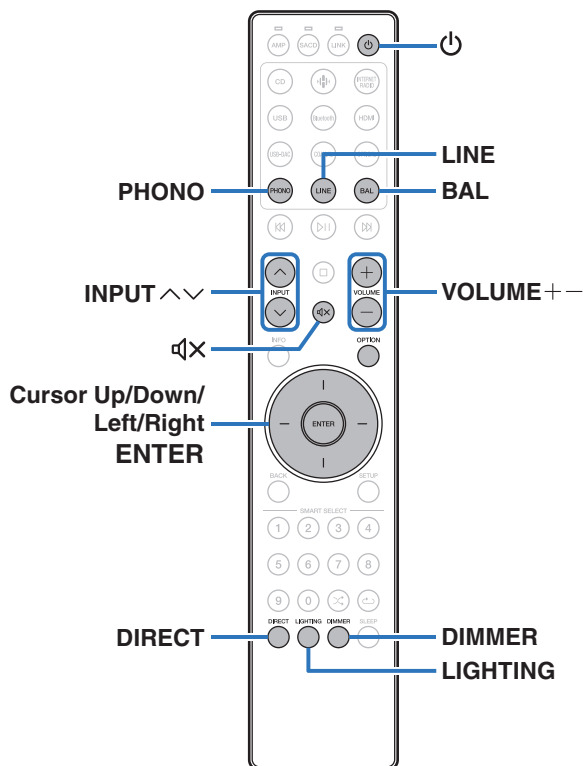

Turning the power on

1 Press to turn on power to the unit.

The display turns on.



- You can also press  on the main unit to turn on power from standby mode.

Switching the power to standby

1 Press .

The unit switches to standby mode.

NOTE

- Power continues to be supplied to some of the circuitry even when the power is in the standby mode. When leaving home for long periods of time or when going on vacation, unplug the power cord from the power outlet.



Selecting the input source

- 1 Use input source select buttons (PHONO/LINE/BAL) to select the input source to be played back.

The selected input source appears on the display.



- This unit switches between Line 1 and Line 2 each time LINE is pressed.
- This unit switches between Balanced 1 and Balanced 2 each time BAL is pressed.
- You can also select the input source by using INPUT \wedge \vee .
- You can also select the input source by turning INPUT selector on the main unit.

Adjusting the volume

- 1 Use VOLUME \pm to adjust the volume.

The volume level appears on the display.



- You can also adjust the volume by turning VOLUME on the main unit.
- You can change how the volume level is displayed. (🔧 p. 50)

Turning off the sound temporarily (Muting)

- 1 Press MUTE .

"Mute" is displayed on the display.



- To cancel mute, either adjust the volume or press MUTE again.



Adjusting the tone and balance

■ Adjusting the tone

1 Press OPTION.

The option menu screen is displayed.

2 Use Cursor Up/Down buttons to select “Tone”, then press ENTER.

3 Use Cursor Up/Down buttons to select “Bass” or “Treble”, then press ENTER.

- If you are using an F.C.B.S. connection, a screen for selecting the F.C.B.S. ID (“Leader”, “Member 1”, “Member 2” or “Member 3”) will appear after step 3. Use Cursor Up/Down buttons to select the ID of the device you want to set, then press ENTER.

4 Use Cursor Up/Down buttons to adjust the bass or treble volume.

Bass: -10 dB – +10 dB (Default: 0 dB)

Treble: -10 dB – +10 dB (Default: 0 dB)



- When the input source is set to “Power Amp Balanced” or “Power Amp Unbalanced”, the tone adjustment function does not work.
- When the source direct mode is turned on, the tone adjustment function does not work.



■ Adjusting the volume balance

1 Press OPTION.

The option menu screen is displayed on the display.

2 Use Cursor Up/Down buttons to select “Trim”, then press ENTER.

3 Use Cursor Left/Right buttons to select “Left” or “Right”.

- If you are using an F.C.B.S. connection, a screen for selecting the F.C.B.S. ID (“Leader”, “Member 1”, “Member 2” or “Member 3”) will appear after step 3. Use Cursor Up/Down buttons to select the ID of the device you want to set, then press ENTER.

4 Use Cursor Up/Down buttons to adjust the volume balance.

Left: $-\infty$ (minimum), -19.0 - 0 (maximum)
(Default: 0)

Right: $-\infty$ (minimum), -19.0 - 0 (maximum)
(Default: 0)



- When the input source is set to “Power Amp Balanced” or “Power Amp Unbalanced”, the volume balance adjustment function does not work.
- When the source direct mode is turned on, the volume balance adjustment function does not work.
- When the source direct mode is turned on, the “Trim” setting is set to 0 (maximum).



Playback in source direct mode

The signal does not pass through the tone adjustment circuitry, resulting in playback of a higher sound quality.

1 Press DIRECT to turn on source direct mode.

“Source Direct” is displayed on the display.



- When the input source is set to “Power Amp Balanced” or “Power Amp Unbalanced”, the source direct function does not work.

Switching the display’s brightness

The display brightness can be adjusted from 100 % to Off (0 %) in steps of 5 %. Switching the display off reduces a source of noise that affects sound quality, enabling higher sound quality playback.

1 Press DIMMER.

The dimmer menu screen is displayed on the display.

2 Use Cursor Up/Down buttons to adjust the brightness of the display.

- You can also adjust the brightness by pressing DIMMER.



- If button operations are made while the display is off, information is temporarily displayed at 100 %.
- The display brightness is set to 100 % by default.
- The display brightness setting is synchronized with the “Illumination” - “Display” setting in the settings menu. (🔧 p. 49)
- DIMMER does not work when LIGHTING is pressed and turned off.



Turning the front panel illumination, interior illumination and display on/off

Turn on/off the front panel illumination, interior illumination and display.

1 Press LIGHTING.

- Each time the button is pressed, the front panel illumination, interior illumination and display are turned on/off.



- In the Settings menu, "Illumination" allows you to set the brightness of the front panel illumination, interior illumination and display. (🔗 p. 49)
- When LIGHTING is pressed and lit, the front panel illumination, interior illumination and display light up to the brightness set in "Illumination" in the Settings menu. (🔗 p. 49)

Using this unit as a power amplifier

When connecting a pre-amplifier and using this unit as a power amplifier, switch the input source of this unit to "Power Amp Balanced" or "Power Amp Unbalanced".

Select "Power Amp Balanced" if the connection is balanced, or "Power Amp Unbalanced" if the connection is unbalanced.

1 Use INPUT \wedge \vee to switch the input source to "Power Amp Balanced" or "Power Amp Unbalanced".

"Power Amp Balanced" or "Power Amp Unbalanced" is displayed on the display.



- When the input source is "Power Amp Balanced" or "Power Amp Unbalanced", adjustment of the volume, balance and tone has no effect. Adjust these adjustments on the pre-amplifier.



NOTE

- When the input source is "Power Amp Balanced" or "Power Amp Unbalanced", the main unit outputs at maximum volume. Check the output level on the input device before playing it and adjust the volume accordingly.



Recording

Audio signals input into this unit can be output to an external recording device. When recording audio from a playback device connected to this unit, audio can be recorded with the playback device still connected to this unit.

- 1 Press  to turn the power on.**
- 2 Use INPUT   to switch to the input source from which you want to record.**

The selected input source appears on the display.

- 3 Recording starts.**
 - For information on operations, see the owner's manual of the recording device.



- When this unit is in standby mode, no audio output from LINE OUT connectors.



Menu map

For menu operations, see the following page.

By default, this unit has recommended settings defined. You can customize this unit based on your existing system and your preferences.

Setting items	Description	Page
Level Meter	Sets whether to display the level meter.	49
Illumination	You can adjust the brightness of the front panel illumination, interior illumination and display. You can also link the front panel illumination and the interior illumination to the brightness of the display. When the brightness is turned "Off", the noise source affecting the sound quality is suppressed, and high-quality sound playback is possible.	49
Volume Scale	Set how the volume is displayed.	50
Phono	Sets the phono equalizer of this unit according to the type or impedance of the turntable cartridge to be connected.	50
Auto-Standby	Sets whether to automatically switch the unit to the standby mode when there is no audio input and no operations are performed for more than 15 minutes.	51



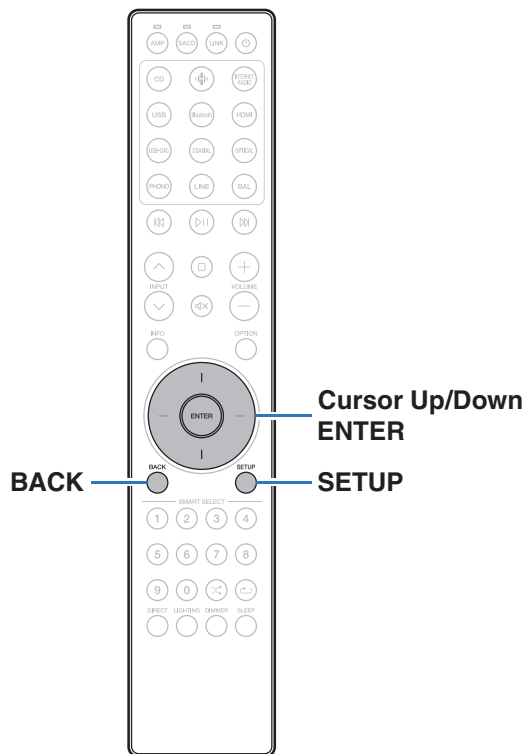

Menu operation

- 1 Press SETUP.**
The setup menu is displayed on the display.
- 2 Use Cursor Up/Down buttons to select the menu to be set or operated, then press ENTER.**
- 3 Use Cursor Up/Down buttons to change to desired setting.**
- 4 Press ENTER to enter the setting.**
 - To return to the previous item, press BACK.
 - Exiting the Menu, press SETUP while the setup menu is displayed. The display returns to the normal display.



Level Meter

Sets whether to display the level meter. The level meter displays the output level.

Off (Default):	The level meter is not displayed.
Power Amp:	The level meter is displayed if the input source is "Power Amp Balanced" or "Power Amp Unbalanced".
On:	The level meter is displayed on all input sources.

Illumination

You can adjust the brightness of the front panel illumination, interior illumination and display. You can also link the front panel illumination and the interior illumination to the brightness of the display. When the brightness is turned "Off", the noise source affecting the sound quality is suppressed, and high-quality sound playback is possible.

■ Display

100 – 5 (Default: 100)

Off



- The display brightness setting is synchronized with the Dimmer menu setting. (👉 p. 44)

■ Front Panel

Sync
(Default):

The brightness of the front panel illumination is linked to the brightness of the display.

100 – 5

Off

■ Interior

Sync
(Default):

The brightness of the interior illumination is linked to the brightness of the display.

100 – 5

Off



Volume Scale

Set how the volume is displayed.

-99.5 dB – 0 dB (Default):	Display volume in relative value.
0 – 100:	Display volume in absolute value.

Phono

Sets the phono equalizer of this unit according to the type or impedance of the turntable cartridge to be connected.

MM (Default):	Set this for an MM cartridge.
MC-Low:	Use this setting for an MC cartridge of less than 50 Ω /ohms.
MC-Mid:	Use this setting for an MC cartridge of about 50 Ω /ohms.
MC-High:	Use this setting for an MC cartridge of 100 Ω /ohms or higher.



- For an MC cartridge, select the input impedance closest to the impedance recommended for the cartridge used or select a value a few times that of the cartridge's internal impedance.
- If this setting change operation is performed, playback sound is output approximately 4 seconds after the change.



Auto-Standby

Sets whether to automatically switch the unit to the standby mode when there is no audio input and no operations are performed for more than 15 minutes.

Off
(Default): Disable Auto Standby mode.

On: Enable Auto Standby mode.



- The display will show the remaining time for three minutes before the units enters standby mode.
- In F.C.B.S. connection, only the ID “Leader” unit activates Auto Standby mode. If the ID “Leader” unit is operated with no audio input, set the Auto Standby mode to off.



Setting remote control codes

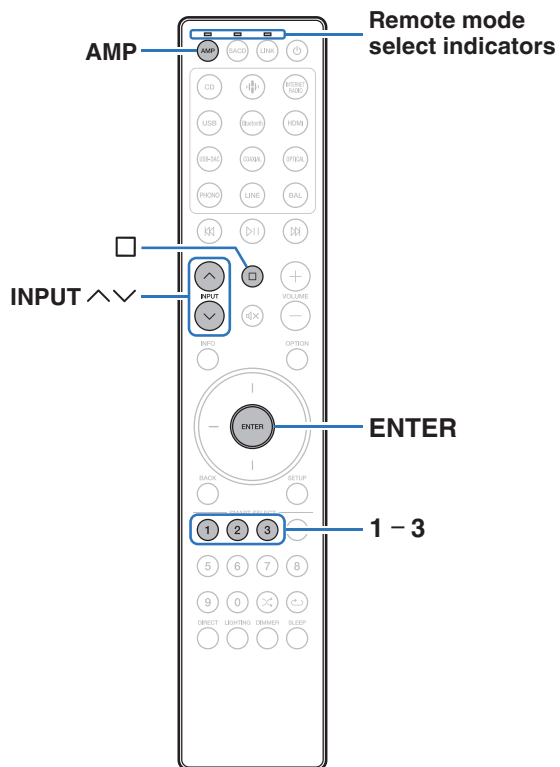

Remote control codes are set between this unit and the included remote control. You can select one of the three types of remote control codes, and the remote control can be used to control the unit when the same remote control code is used. If three of these units are used in the same location, all three units can be controlled simultaneously using one remote control in the default settings. By setting individual remote control codes between a unit and the remote control, the remote control can be used to control only the unit that has the same remote control code.

Be sure to check the operation of each unit after setting the remote control codes.

The default setting is “AMP 1”.



- Set the remote control cord to “AMP 1” when controlling this unit from a Marantz SACD player, streaming preamplifier or other device connected using a remote connection cable to this unit. (p. 37)



Setting remote control codes for the remote control

■ To set the remote control codes to AMP 1, AMP 2 or AMP 3

- 1 Press AMP.**
 - Set the remote control to amplifier operating mode.
- 2 Hold down \square and one of the number 1, 2 or 3 buttons for more than 5 seconds.**

The remote mode select indicators will flash green.

 - Set the remote control code to AMP 1, AMP 2 or AMP 3 according to the selected number button.

Setting remote control codes for the main unit

- 1 Point the remote control for which the remote control code was set at the main unit, and press \square and ENTER.**

When setting the remote control code of the main unit is complete, the remote control code set (AMP 1 – 3) is displayed on the display.



Disabling SACD player/streaming preamplifier operating mode on remote control

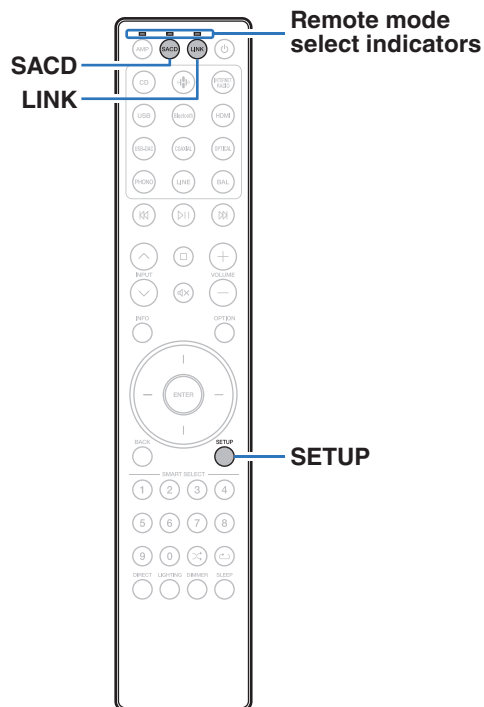

If you do not want to use this unit in combination with SACD 10 or LINK 10n, you can disable the remote control operating mode of the device that you are not using. By default, all remote control operating modes are enabled.



- When remote control operating mode is enabled, be sure to check the operation of your device.



Disabling SACD player operating mode

- 1 Press and hold SACD and SETUP simultaneously until the remote mode select indicators flash green.**
 - Each time you perform Step 1, the SACD player operating mode is toggled between enabled/disabled.

Disabling streaming preamplifier operating mode

- 1 Press and hold LINK and SETUP simultaneously until the remote mode select indicators flash green.**
 - Each time you perform Step 1, the streaming preamplifier operating mode is toggled between enabled/disabled.



Setting the device to be operated by the volume buttons on the remote control

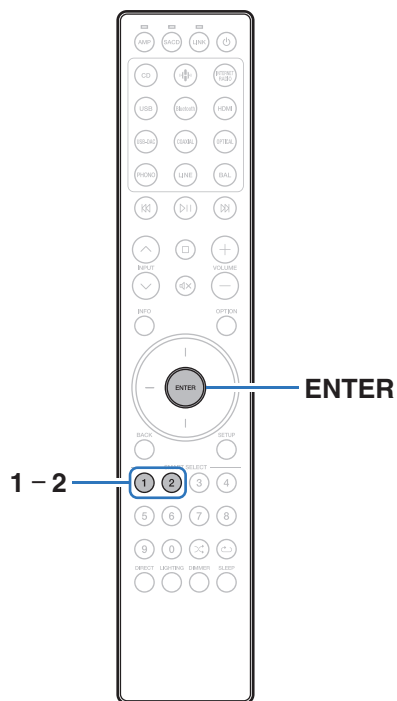

On the included remote control, you can set the device to be operated by the volume buttons so that you can adjust the volume of this unit when it is either in SACD player operating mode or streaming preamplifier operating mode. You can select either “Amplifier” or “Streaming Preamplifier” as the device to be operated by the volume buttons on the remote control.



- After setting the device to be operated by the volume buttons on the remote control, be sure to check the operation of your device.
- Switching the device to be operated affects the VOLUME +— and X buttons on the remote control.



Setting the device to be operated by the volume buttons in SACD player operating mode

If you use a Marantz SACD player in combination with this unit, you can adjust the volume of this unit without switching to amplifier operating mode while the included remote control is set to SACD player operating mode. By default, the device to be operated is set to “Amplifier”.

■ Set the device to be operated by the volume buttons to this unit (amplifier)

1 Press and hold ENTER and 1 on the remote control simultaneously for 5 seconds or more.

The AMP indicator will flash green.

■ Set the device to be operated by the volume buttons to the streaming preamplifier

1 Press and hold ENTER and 2 on the remote control simultaneously for 5 seconds or more.

The LINK indicator will flash green.

Setting the device to be operated by the volume buttons in streaming preamplifier operating mode

If you use a Marantz streaming preamplifier in combination with this unit, you can adjust the volume of this unit without switching to amplifier operating mode while the included remote control is set to streaming preamplifier operating mode.

By default, the device to be operated is set to “Streaming Preamplifier”.

■ Set the device to be operated by the volume buttons to the streaming preamplifier

1 Press and hold ENTER and 1 on the remote control simultaneously for 5 seconds or more.

The LINK indicator will flash green.

■ Set the device to be operated by the volume buttons to this unit (amplifier)

1 Press and hold ENTER and 2 on the remote control simultaneously for 5 seconds or more.

The AMP indicator will flash green.



■ Contents

Tips

I want to adjust the tone myself	59
I want to turn the display off	59
I want to turn off the front panel illumination, interior illumination and display	59
I want to use two or more of MODEL 10 units for high quality playback	59
I want to operate a Marantz SACD player and streaming preamplifier using the remote control of this unit	59
I want to use this unit as a power amplifier	59
I want to use this unit as a pre-amplifier	59
I want to use more than one unit in one location	59

Troubleshooting

Power does not turn on / Power is turned off	61
Operations cannot be performed through the remote control unit	63
Display on this unit shows nothing	64
No sound comes out	64
Desired sound does not come out	65
Sound is interrupted or noise occurs	66



Tips

I want to adjust the tone myself

- Press the OPTION button to adjust “Tone” setting on the option menu. (👉 p. 42)

I want to turn the display off

- Press the DIMMER button to adjust the display’s brightness on the dimmer menu. (👉 p. 44)

I want to turn off the front panel illumination, interior illumination and display

- Press the LIGHTING button to turn off. (👉 p. 45)

I want to use two or more of MODEL 10 units for high quality playback

- Use the stereo complete bi-amp connections. (👉 p. 29)
- Use the multi-channel playback connections. (👉 p. 31)

I want to operate a Marantz SACD player and streaming preamplifier using the remote control of this unit

- Marantz SACD player and streaming preamplifier can also be operated with the remote control of this unit. Also refer to the SACD player and streaming preamplifier instruction manuals for those players. (👉 p. 13)

I want to use this unit as a power amplifier

- Connect a pre-amplifier to the POWER AMP IN connectors of this unit and switch the input source to “Power Amp Balanced” or “Power Amp Unbalanced”. (👉 p. 24)

I want to use this unit as a pre-amplifier

- Connect a power amplifier to the PREAMP OUT connectors of this unit. (👉 p. 24)

I want to use more than one unit in one location

- Set individual remote control codes for each combination of devices and remote control. (👉 p. 52)



Troubleshooting

If a problem should arise, first check the following:

1. **Are the connections correct?**
2. **Is the set being operated as described in the owner's manual?**
3. **Are the other devices operating properly?**

If this unit does not operate properly, check the corresponding symptoms in this section.

If the symptoms do not match any of those described here, consult your dealer as it could be due to a fault in this unit. In this case, disconnect the power immediately and contact the store where you purchased this unit.



Power does not turn on / Power is turned off

Power is not turned on.

- Check whether the power plug is correctly inserted into the power outlet. (👉 p. 38)
- This unit is in standby mode. Press the ⏻ button on the main unit or the ⏻ button on the remote control. (👉 p. 40)

Power automatically turns off.

- The Auto Standby mode is on. When approx. 15 minutes pass with no audio input and no operations on the unit, this unit automatically enters the standby mode. To turn off the Auto Standby mode, set “Auto-Standby” on the setup menu to “Off”. (👉 p. 51)
- When this unit and a Marantz audio device compatible with the power synchronization function are connected using a remote connection cable, the power of this unit turns off (standby) in synchronization with the power off operation of the device connected to this unit. (👉 p. 36)

The power turns off and the power indicator shows one long blink and two short blinks in orange.

- Stop playback on the playback device, and then turn the power off and on again.
- If the problem is not solved by turning the power off and on again, this unit’s amplifier circuit has failed. Unplug the power cord and contact our customer service center.

The power turns off and the power indicator shows one long blink and three short blinks in orange.

- This unit’s power circuit has failed. Unplug the power cord and contact our customer service center.



The power turns off and the power indicator shows one long blink and four short blinks in orange.

- The protection circuit has been activated due to a rise in temperature within this unit. Turn the power off, wait about an hour until this unit cools down sufficiently, and then turn the power on again.
- Please re-install this unit in a place having good ventilation.
- Stop playback on the playback device, and then turn the power off and on again.

The power turns off and the power indicator shows one long blink and five short blinks in orange.

- Check the speaker connections. The protection circuit may have been activated because speaker cable core wires came in contact with each other or a core wire was disconnected from the connector and came in contact with the rear panel of this unit. After unplugging the power cord, take corrective action such as firmly re-twisting the core wire or taking care of the connector, and then reconnect the wire. (☞ p. 17)
- Stop playback on the playback device, and then turn the power off and on again.
- If the problem is not solved by turning the power off and on again, this unit's amplifier circuit or power circuit has failed. Unplug the power cord and contact our customer service center.

The power turns off and the power indicator shows one long blink and six short blinks in orange.

- This unit's power circuit has failed. Unplug the power cord and contact our customer service center.



Operations cannot be performed through the remote control unit

Operations cannot be performed through the remote control unit.

- Batteries are worn out. Replace with new batteries. (🔍 p. 5)
- Operate the remote control unit within a distance of about 23 ft/7 m from this unit and at an angle of within 30°. (🔍 p. 5)
- Remove any obstacle between this unit and the remote control unit.
- Insert the batteries in the proper direction, checking the ⊕ and ⊖ marks. (🔍 p. 5)
- The set's remote control sensor is exposed to strong light (direct sunlight, inverter type fluorescent bulb light, etc.). Move the set to a place in which the remote control sensor will not be exposed to strong light.
- When using a 3D video device, the remote control unit of this unit may not function due to effects of infrared communications between units (such as TV and glasses for 3D viewing). In this case, adjust the direction of units with the 3D communications function and their distance to ensure they do not affect operations from the remote control unit of this unit.
- Press the AMP button to switch the remote control operating mode to amplifier operating mode. (🔍 p. 11)
- Remote control amplifier operating mode is disabled. Press and hold the AMP and SETUP buttons simultaneously for 3 seconds or more to enable amp operating mode.
- The device to be operated by the VOLUME + and 🔊 buttons is a Marantz streaming preamplifier. If the remote control is in SACD player operation mode and the volume of this unit cannot be adjusted, switch the device to be operated to this unit. (🔍 p. 57)
- The device to be operated by the VOLUME + and 🔊 buttons is a Marantz streaming preamplifier. If the remote control is in streaming preamplifier operation mode and the volume of this unit cannot be adjusted, switch the device to be operated to this unit. (🔍 p. 57)
- The remote control code between this unit and the remote control is different. Set this unit and the remote control to the same remote control code. (🔍 p. 52)
- The EXTERNAL/INTERNAL switch should be switched to "INTERNAL" if the Marantz audio device is not remotely connected and is used only with this unit. (🔍 p. 36)



Display on this unit shows nothing

Display is off.

- Press the DIMMER button, and change the setting to anything other than “Off” on the dimmer menu. (👉 p. 44)
- Press the LIGHTING button to turn on the lighting. (👉 p. 45)
- Set “Illumination” – “Display” on the setup menu to something other than “Off”. (👉 p. 49)

No sound comes out

No sound comes out of speakers.

- Check the connections for all devices. (👉 p. 16)
- Insert connection cables all the way in.
- Check that input connectors and output connectors are not reversely connected.
- Check cables for damage.
- Check that speaker cables are properly connected. Check that cable core wires come in contact with the metal part on speaker terminals. (👉 p. 17)
- Securely tighten the speaker terminals. Check speaker terminals for looseness. (👉 p. 17)
- Check that the proper input source is selected. (👉 p. 41)
- The volume is set to the minimum level. Adjust the volume to a suitable level. (👉 p. 41)
- Cancel the muting mode. (👉 p. 41)



Desired sound does not come out

No sound comes out of a specific speaker.

- Check that speaker cables are properly connected. (🔗 p. 17)
- Press the OPTION button and use “Trim” on the option menu to adjust the left/right volume balance. (🔗 p. 43)

The left and right of stereo sound is reversed.

- Check whether the left and right speakers are connected to the correct speaker terminals. (🔗 p. 17)

The settings of the “Bass”, “Treble” and “Trim” are not applied.

- Press the DIRECT button to turn off source direct mode. (🔗 p. 44)

Sound is not correctly output from the power amplifier connected to the PREAMP OUT connectors.

- Check the power amplifier connections. (🔗 p. 24)

Sound is not correctly output from the pre amplifier connected to the POWER AMP IN connectors.

- Check the pre amplifier connections. (🔗 p. 24)
- Check the the input source of this unit is set to “Power Amp Balanced” or “Power Amp Unbalanced”. (🔗 p. 41)



Sound is interrupted or noise occurs

When playing a record, the sound is distorted.

- Adjust to a proper needle pressure.
- Check the tip of the needle.
- Replace the cartridge.

When playing a record, a humming noise comes out of the speakers.

- Check that the turntable is connected correctly. (👉 p. 21)
- If there is a TV or AV device near the turntable, such devices may affect the playback sound. Install the turntable in a location as far away as possible from the TV or other AV devices.

When playing a record, a humming noise comes out of the speakers when the volume is high. (Howling phenomenon)

- Install the turntable and speakers as far from each other as possible. (👉 p. 21)
- The vibrations from the speakers are being transmitted to the player through the floor. Use cushions, etc., to absorb the speakers' vibrations.



Error messages

When multiple MODEL 10 units are connected by F.C.B.S., the error messages described in the table below may be displayed on the display. In such a case, ID setting or remote cable connection may be in failure. Check the ID or remote cable connection, referring to the table below. For details on ID setting, see "How to set ID for F.C.B.S." (📖 p. 28).

Error Code	Meaning	Cause / Solution
001	Multiple amplifiers take ID "Member 1".	<ul style="list-style-type: none"> Assign different IDs to the amplifiers.
002	Multiple amplifiers take ID "Member 2".	
003	Multiple amplifiers take ID "Member 3".	
011	The amplifiers with ID "Member 1 - 3" cannot communicate with the amplifier with ID "Leader".	<ul style="list-style-type: none"> If the amplifier with ID "Leader" is not on, turn it ON. Check that the remote cable is properly connected.
012	The amplifier with ID "Leader" cannot communicate with the amplifiers with ID "Member 1 - 3".	<ul style="list-style-type: none"> If multiple amplifiers take ID "Leader", set IDs properly. If the amplifier with ID "Leader" is connected to the amplifier with ID "Off", set IDs properly. Check that the remote cable is properly connected.



Explanation of terms

MM/MC cartridge

There are two types--MM (Moving Magnet) and MC (Moving Coil)--of cartridges for turntable. As the output levels for these two types of cartridges differ, the setting of the phono equalizer that is mounted in this unit must be switched according to the type of cartridge for your turntable. Change this setting in the "Phono" section of the setup menu. (👉 p. 50)

Source direct

Playback with higher fidelity to the source becomes possible, as input audio signals are output by bypassing the tone control circuits (Bass/Treble/Trim).

Speaker impedance

This is an AC resistance value, indicated in Ω (ohms). Greater power can be obtained when this value is smaller.

Protection circuit

This is a function to prevent damage to devices within the power supply when an abnormality such as an overload, excess voltage occurs or over temperature for any reason.



Specifications

- **RMS Power output (Simultaneous drive of both channels) :**
 - 250 W x 2 (8 Ω /ohms load, 20 Hz - 20 kHz, T.H.D. 0.05 %)
 - 500 W x 2 (4 Ω /ohms load, 20 Hz - 20 kHz, T.H.D. 0.05 %)
- **Distortion (THD+N, CCIF IMD, DFD IMD)
(20 Hz - 20 kHz, simultaneous driven of both channels,
125 W, 8 Ω /ohms load, AES 20 kHz LPF) :**
 - 0.005 %
- **Frequency response (CD, 1 W, 8 Ω /ohms load) :**
 - 5 Hz - 60 kHz +0 dB/-3 dB
 - 20 Hz - 20 kHz +0 dB/-0.3 dB
- **Damping factor (8 Ω /ohms load, 20 Hz - 20 kHz) :**
 - 500
- **Input sensitivity/Input impedance**
 - PHONO (MC Low) : 400 μ V / 33 Ω /ohms
 - PHONO (MC Mid) : 400 μ V / 100 Ω /ohms
 - PHONO (MC High) : 400 μ V / 390 Ω /ohms
 - PHONO (MM) : 3.6 mV / 39 k Ω /kohms
 - BALANCED 1/BALANCED 2 : 700 mV / 36 k Ω /kohms
 - LINE 1/LINE 2/RECORDER : 350 mV / 47 k Ω /kohms
 - POWER AMP UNBALANCED : 1.58 V / 47 k Ω /kohms
 - POWER AMP BALANCED : 3.16 V / 15 k Ω /kohms
- **Output voltage/Output impedance**
 - PREOUT UNBALANCED : 1.58 V / 230 Ω /ohms
 - PREOUT BALANCED : 3.17 V / 480 Ω /ohms



- **Maximum allowable PHONO input level (1 kHz)**
 - MC :** 8 mV
 - MM :** 80 mV
- **RIAA deviation (20 Hz – 20 kHz) :** ±0.5 dB
- **S/N (IHF-A, 8 Ω/ohms load)**
 - PHONO (MC) :** 76 dB (0.5 mV Input, 1 W Output)
 - PHONO (MM) :** 88 dB (5 mV Input, 1 W Output)
 - BALANCED 1/BALANCED 2 :** 122 dB (4 V Input, Rated output)
 - LINE 1/LINE 2/RECORDER :** 122 dB (2 V Input, Rated output)
- **Tone control**
 - BASS (50 Hz) :** ±10 dB
 - TREBLE (15 kHz) :** ±10 dB
- **Operating temperature:** 41 °F - 95 °F (5 °C - 35 °C)
- **Power requirement :** AC 120 V, 60 Hz
- **Power consumption :** 270 W
- **Power consumption in standby mode :** 0.1 W

For the purpose of improvement, the specifications and design are subject to change without notice.



■ Dimensions (Unit : in. (mm))

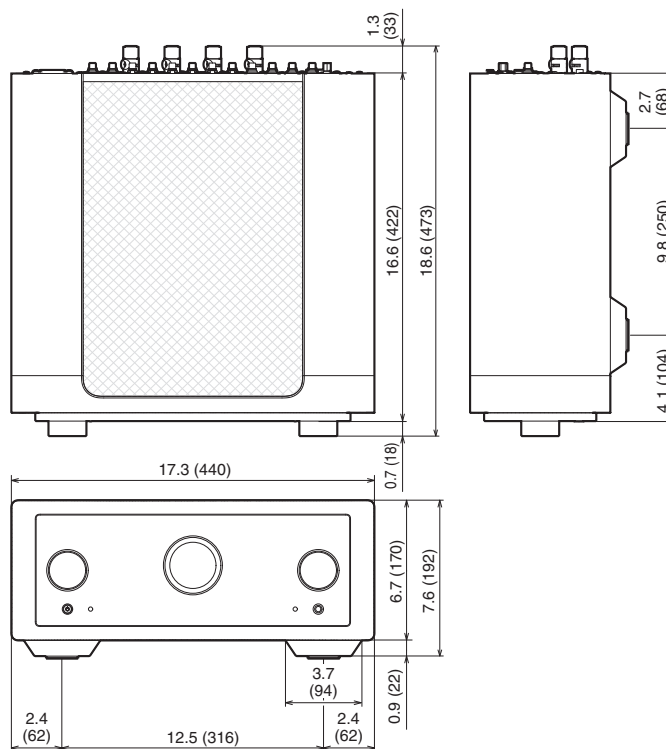

■ Weight : 74 lbs 5 oz (33.7 kg)



Index

A		
Auto Standby mode	51	
C		
CD player	21	
F		
Front panel	6	
I		
Input source	41	
M		
Muting	41	
N		
Network audio player	21	
P		
Power amplifier	24	
Pre-amplifier	24	
Protection circuit	68	
R		
Rear panel	9	
Recording device	23	
Remote control codes settings	53	
Remote control unit	11	
S		
Speaker impedance	68	
Speakers	17	
T		
Tips	59	
Tone	42	
Troubleshooting	60	
Turntable	21	
V		
Volume	41	



marantz

3520 10983 00AS

© 2024 Masimo. All Rights Reserved.