

Panasonic[®]

OPERATING INSTRUCTIONS

TV-32S50AEY
TV-32S55AEY

LED TV

Table of Contents

Safety Information	2
Maintenance	4
Assembling / Removing the pedestal	4
When using the wall-hanging bracket.....	5
Introduction.....	5
Accessories Included.....	5
Features	5
Antenna Connection.....	5
Other Connections.....	6
Turning On/Off the TV	7
TV Control & Operation	7
Remote Control	9
Initial Setup Wizard.....	10
Main Screen	11
Live TV	12
Customising TV Settings	12
Settings.....	13
Channel List.....	25
Channel Guide.....	25
Connecting to the Internet	25
Specification	27
Notice	28
Licences	28
Declaration of Conformity (DoC)	30
UK Declaration of Conformity (DoC)	30
Sales and Support Information	30
Important Instruction.....	31

Safety Information

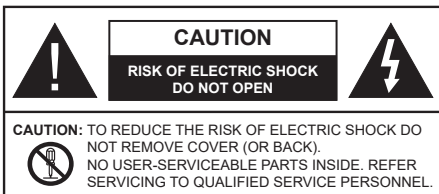

In extreme weather (storms, lightning) and long inactivity periods (going on holiday) disconnect the TV set from the mains.

The mains plug is used to disconnect TV set from the mains and therefore it must remain readily operable. If the TV set is not disconnected electrically from the mains, the device will still draw power for all situations even if the TV is in standby mode or switched off.

Note: Follow the on screen instructions for operating the related features.

IMPORTANT - Please read these instructions fully before installing or operating

WARNING: This device is intended to be used by persons (including children) who are capable / experienced of operating such a device unsupervised, unless they have been given supervision or instruction concerning the use of the device by a person responsible for their safety.

- Use this TV set at an altitude of less than 5000 metres above the sea level, in dry locations and in regions with moderate or tropical climates.
- The TV set is intended for household and similar indoor use but may also be used in public places.
- For ventilation purposes, leave at least 5cm of free space around the TV.
- The ventilation should not be impeded by covering or blocking the ventilation openings with items, such as newspapers, table-cloths, curtains, etc.
- The power cord/plug should be easily accessible. Do not place the TV, furniture, etc. on the power cord. A damaged power cord/plug can cause fire or give you an electric shock. Handle the power cord by the plug, do not unplug the TV by pulling the power cord. Never touch the power cord/plug with wet hands as this could cause a short circuit or electric shock. Never make a knot in the power cord or tie it with other cords. When damaged it must be replaced, this should only be done by qualified personnel.
- Do not expose the TV to dripping or splashing of liquids and do not place objects filled with liquids, such as vases, cups, etc. on or over the TV (e.g. on shelves above the unit).

- Do not expose the TV to direct sunlight or do not place open flames such as lit candles on the top of or near the TV.
- Do not place any heat sources such as electric heaters, radiators, etc. near the TV set.
- Do not place the TV on the floor or inclined surfaces.
- To avoid danger of suffocation, keep plastic bags out of the reach of babies, children and domestic animals.
- Carefully attach the stand to the TV. If the stand is provided with screws, tighten the screws firmly to prevent the TV from tilting. Do not over-tighten the screws and mount the stand rubbers properly.
- Do not dispose of the batteries in fire or with hazardous or flammable materials.

WARNING

- Batteries must not be exposed to excessive heat such as sunshine, fire or the like.
- Excessive sound pressure from earphones or headphones can cause hearing loss.

ABOVE ALL - NEVER let anyone, especially children, push or hit the screen, push anything into holes, slots or any other openings in the TV.

Caution	Serious injury or death risk
Risk of electric shock	Dangerous voltage risk
Maintenance	Important maintenance component

Markings on the Product

The following symbols are used on the product as a marker for restrictions and precautions and safety instructions. Each explanation shall be considered where the product bears related marking only. Note such information for security reasons.



Class II Equipment: This appliance is designed in such a way that it does not require a safety connection to electrical earth.



Hazardous Live Terminal: The marked terminal(s) is/are hazardous live under normal operating conditions.



Caution, See Operating Instructions: The marked area(s) contain(s) user replaceable coin or button cell batteries.



Class 1 Laser Product: This product contains Class 1 laser source that is safe under reasonably foreseeable conditions of operation.

WARNING

- Do not ingest the battery, Chemical Burn Hazard.
- This product or the accessories supplied with the product may contain a coin/button cell battery. If the coin/button cell battery is swallowed, it can cause severe internal burns in just 2 hours and can lead to death.
- Keep new and used batteries away from children.
- If the battery compartment does not close securely, stop using the product and keep it away from children.
- If you think batteries might have been swallowed or placed inside any part of the body, seek immediate medical attention.

A television may fall, causing serious personal injury or death. Many injuries, particularly to children, can be avoided by taking simple precautions such as:

- ALWAYS use cabinets or stands or mounting methods recommended by the manufacturer of the television set.
- ALWAYS use furniture that can safely support the television set.
- ALWAYS ensure the television set is not overhanging the edge of the supporting furniture.
- ALWAYS educate children about the dangers of climbing on furniture to reach the television set or its controls.
- ALWAYS route cords and cables connected to your television so they cannot be tripped over, pulled or grabbed.
- NEVER place a television set in an unstable location.
- NEVER place the television set on tall furniture (for example, cupboards or bookcases) without anchoring both the furniture and the television set to a suitable support.
- NEVER place the television set on cloth or other materials that may be located between the television set and supporting furniture.
- NEVER place items that might tempt children to climb, such as toys and remote controls, on the top of the television or furniture on which the television is placed.
- The equipment is only suitable for mounting at heights ≤ 2 m.

If the existing television set is going to be retained and relocated, the same considerations as above should be applied.

Apparatus connected to the protective earthing of the building installation through the MAINS connection or through other apparatus with a connection to protective earthing – and to a television distribution system using

coaxial cable, may in some circumstances create a fire hazard. Connection to a television distribution system has therefore to be provided through a device providing electrical isolation below a certain frequency range (galvanic isolator).

WALL MOUNTING WARNINGS

- Read the instructions before mounting your TV on the wall.
- The wall mount kit is optional. You can obtain from your local dealer, if not supplied with your TV.
- Do not install the TV on a ceiling or on an inclined wall.
- Use the specified wall mounting screws and other accessories.
- Tighten the wall mounting screws firmly to prevent the TV from falling. Do not over-tighten the screws.

- Using other wall-hanging brackets, or installing a wall-hanging bracket by yourself have the risk of personal injury and product damage. In order to maintain the unit's performance and safety, be absolutely sure to ask your dealer or a licensed contractor to secure the wall-hanging brackets. Any damage caused by installing without a qualified installer will void your warranty.
- Carefully read the instructions accompanying optional accessories, and be absolutely sure to take steps to prevent the TV from falling off.
- Handle the TV carefully during installation since subjecting it to impact or other forces may cause product damage.
- Take care when fixing wall brackets to the wall. Always ensure that there are no electrical cables or pipes in the wall before hanging bracket.
- To prevent fall and injury, remove the TV from its fixed wall position when it is no longer in use.

DAMAGES

- Excepting cases where responsibility is recognised by local regulations, Panasonic accepts no responsibility for malfunctions caused by misuse or use of the product, and other problems or damages caused by use of this product.
- Panasonic accepts no responsibility for loss, etc., of data caused by disasters.
- External devices separately prepared by the customer are not covered by the warranty. Care for the data stored in such devices is the responsibility of the customer. Panasonic accepts no responsibility for abuse of this data.

Figures and illustrations in these operating instructions are provided for reference only and may differ from the actual product appearance. Product design and specifications may be changed without notice.

Because the Fire TV operating system is periodically updated, the images, navigation instructions, titles and location of menu options shown in this manual may be different from what you see on the screen.

Maintenance

First, remove the mains plug from the mains socket.

Display panel, Cabinet, Pedestal

Regular care:

Gently wipe the surface of the display panel, cabinet, or pedestal by using a soft cloth to remove dirt or fingerprints.

For stubborn dirt:

1. First clean the dust from the surface.
2. Dampen a soft cloth with clean water or diluted neutral detergent (1 part detergent to 100 parts water).
3. Wring out the cloth firmly. (Please note, do not let liquid enter the TV inside as it may lead to product failure.)
4. Carefully wipe moisten and wipe away the stubborn dirt.
5. Finally, wipe away all the moisture.

Caution

Do not use a hard cloth or rub the surface too hard, otherwise this may cause scratches on the surface.

- Take care not to subject the surfaces to insect repellent, solvent, thinner or other volatile substances. This may degrade surface quality or cause peeling of the paint.
- The surface of the display panel is specially treated and may be easily damaged. Take care not to tap or scratch the surface with your fingernail or other hard objects.
- Do not allow the cabinet and pedestal to make contact with a rubber or PVC substance for a long time. This may degrade surface quality.

Mains plug

Wipe the mains plug with a dry cloth at regular intervals.

Moisture and dust may cause fire or electrical shock.

Assembling / Removing the pedestal

Preparations

Take out the pedestal(s) and the TV from the packing case and put the TV onto a work table with the screen panel down on the clean and soft cloth (blanket, etc.)

- Use a flat and firm table bigger than the TV.
- Do not hold the screen panel part.
- Make sure not to scratch or break the TV.

CAUTION: Please refrain from inserting pictured screws to the TV body when not using the TV stand e.g. wall hanging. Inserting screws without pedestal may cause a damage of the TV.

Assembling the pedestal

1. The stand of the TV consists of two pieces. Install these pieces together.

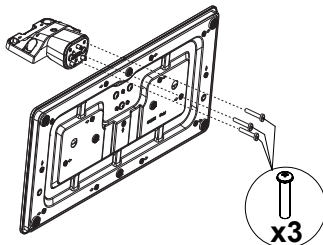

2. Place the stand(s) on the stand mounting pattern(s) on the rear side of the TV.

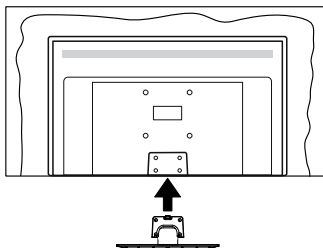

3. Insert the screws (M4 x 12 mm) provided and tighten them gently until the stand is properly fitted.

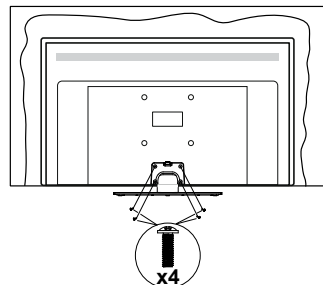

Removing the pedestal from the TV

Be sure to remove the pedestal in the following way when using the wall-hanging bracket or repacking the TV.

- Put the TV onto a work table with the screen panel down on the clean and soft cloth. Leave the stand(s) protruding over the edge of the surface.
- Unscrew the screws that fixing the stand(s).
- Remove the stand(s).

When using the wall-hanging bracket

Please contact your local Panasonic dealer to purchase the recommended wall-hanging bracket.

Holes for wall-hanging bracket installation;

Rear of the TV

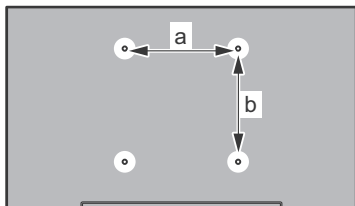

a (mm)	75
b (mm)	75

View from the side

VESA
Bracket

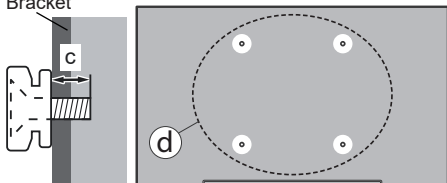

(d)	Depth of screw (c)	min.	9 mm
		max.	10 mm
	Diameter		M4

Note: The screws for fixing the TV onto the wall-hanging bracket are not supplied with the TV.

Introduction

Thank you for choosing our product. You'll soon be enjoying your new TV. Please read these instructions carefully. They contain important information which will help you get the best from your TV and ensure safe and correct installation and operation.

Accessories Included

- Remote Control
- Batteries: 2 x AAA
- Quick Start Guide
- Power Cord
- Detachable stand
- Stand mounting screws (M4 x 12 mm)

Features

High Dynamic Range (HDR) / Hybrid Log-Gamma (HLG)

Using this feature the TV can reproduce greater dynamic range of luminosity by capturing and then combining several different exposures. HDR/HLG promises better picture quality thanks to brighter, more realistic highlights, more realistic colour and other improvements. It delivers the look that filmmakers intended to achieve, showing the hidden areas of dark shadows and sunlight with full clarity, colour and detail. HDR/HLG content is supported via native and market applications, HDMI and USB inputs. When the input source is set to the related HDMI input, highlight the related HDMI option in the **Home > Settings > Display & Audio > Picture Settings** menu and press **Select** to display setting options. Set the **HDMI Input Mode** option in the **Advanced Settings** menu as **Mode 1 (1.4)**, **Mode 2 (2.0)**, or **Auto** in order to watch HDR/HLG content, if the HDR/HLG content is received through an HDMI input. The source device should also be at least HDMI 2.0a compatible in this case.

Antenna Connection

Connect the aerial or cable TV plug to the aerial input (ANT) socket located on the rear side of the TV.

Rear side of the TV

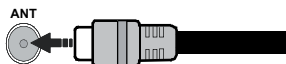











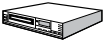



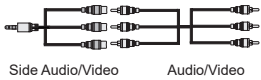
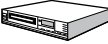



 If you want to connect a device to the TV, make sure that both the TV and the device are turned off before making any connection. After the connection is done, you can turn on the units and use them.

Other Connections



If you want to connect a device to the TV, make sure that both the TV and the device are turned off before making any connection. After the connection is done, you can turn on the units and use them.

Connector	Type	Cables	Device
	HDMI Connection (side&back)		
	SPDIF (Coaxial Out) Connection (side)		
	Side AV (Audio/ Video) Connection (side)	 Side Audio/Video Connection Cable Audio/Video Cable	
	Headphone Connection (side)		
	USB Connection (side)		
	CI Connection (side)		
	Ethernet Connection (back)	 LAN / Ethernet Cable	

When using the wall mounting kit (contact your dealer to purchase one, if not supplied), we recommend that you plug all your cables into the back of the TV before mounting on the wall. Insert or remove the CI module only when the TV is SWITCHED OFF. You should refer to the module instruction manual for details of the settings. The/Each USB input on the TV support devices up to 500mA. Connecting devices that have current value above 500mA may damage your TV. When connecting equipment using a HDMI cable to your TV, to guarantee sufficient immunity against parasitic frequency radiation, you have to use a high speed shielded (high grade) HDMI cable with ferrites.

Turning On/Off the TV

Connect power

IMPORTANT: The TV set is designed to operate on 220-240V AC, 50 Hz socket.

After unpacking, allow the TV set to reach the ambient room temperature before you connect the set to the mains.

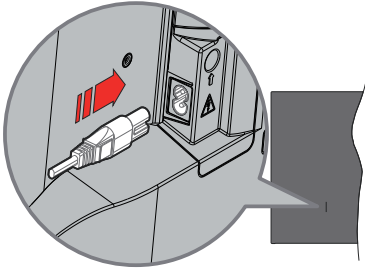

Plug one end (the two-hole plug) of the supplied detachable power cord into the power cord inlet on the rear side of the TV as shown above. Then plug the other end of the power cord into the mains socket outlet. The TV will switch to standby mode.

Note: The position of the power cord inlet may differ depending on the model.

To switch on the TV from standby

If the TV is in standby mode the standby LED lights up. To switch on the TV from standby mode either:

- Press the **Standby** button on the remote control.
- Press the control button on the TV.

The TV will then switch on.

To switch the TV into standby

- Press the **Standby** button on the remote control.
- Press the control button on the TV, the function options menu will be displayed. The focus will be on the **Inputs** option. Press the button consecutively until the **Power Off** option is highlighted. Press and hold the button for about 2 seconds, the TV will switch into standby mode.

To switch off the TV

To power down the TV completely, unplug the power cord from the mains socket.

TV Control & Operation

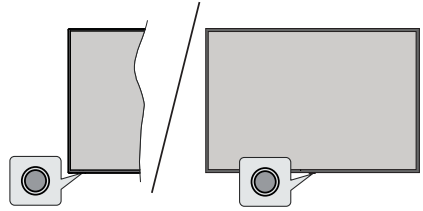

Your TV has a single control button. This button allows you to control the Inputs / Volume Up-Down / Channel Up-Down / Power On-Off / Exit functions of the TV.

Note: The position of the control button may differ depending on the model.

Operating with the Control Button

- Press the control button to display the **Power Menu**.
- Then press the button consecutively to move the focus to the desired option if needed.
- Press and hold the button for about 2 seconds to use the function, enter the sub menu or select the option.

To turn the TV off: Press the control button to display the **Power Menu**, the focus will be on the **Inputs** option. Press the button consecutively until the **Power Off** option is highlighted. Press and hold the button for about 2 seconds to turn the TV off (standby mode).

To turn on the TV: Press the control button, the TV will turn on.

To change volume: Press the control button to display the function options menu and then press the button consecutively to move the focus to **Volume Up** or **Volume Down** option. Press and hold the button to increase or decrease the volume.

To change channel (in Live TV mode): Press the control button to display the **Power Menu** and then press the button consecutively to move the focus to **Channel Up** or **Channel Down** option. Press and hold the button to switch to the next or previous channel in the channel list.

To change input: Press the control button to display the **Power Menu**, the focus will be on the **Inputs** option. Press and hold the button for about 2 seconds to display the inputs list. Scroll through the available input options by pressing the button. Press and hold the button for about 2 seconds to switch to the highlighted input option.

Note: Live TV settings menu OSD in Live TV mode cannot be displayed via the control button.

Operation with the Remote Control

Press and hold the **Home** button on your remote control to display available quick settings menu options when in Live TV mode. Press the **Home** button to display

or return to the Home screen of your Fire TV. Use the directional buttons to move the focus, proceed, adjust some settings and press **Select** to make selections in order to make changes, set your preferences, enter a sub-menu, launch an application etc. Press **Return/Back** to return to the previous menu screen.

Input Selection

Once you have connected external systems to your TV, you can switch to different input sources. Press the **Input** button to open the **Inputs** menu (availability depends on the model of the remote). You can also press and hold the **Home** button on your remote control to display available quick settings menu options and then highlight the **Inputs** option and press the **Select** button to display the list of available input options. Use the directional buttons to highlight the option of your choice and then press the **Select** button to switch to the selected input. Or select the desired input from the **Inputs** row in the inputs tab on the Home screen and press **Select**.

Changing Channels and Volume

You can adjust the volume by using the **Volume +/-** buttons and change the channel in Live TV mode by using the **Programme +/-** buttons on the remote.

Remote Control

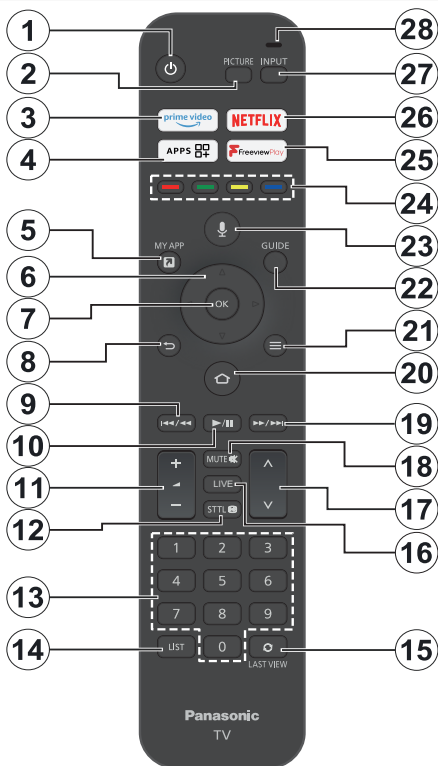

1. **Standby:** Standby / On
2. **Picture:** Opens the picture mode
3. **Prime Video:** Opens Prime Video screen
4. **Apps:** Displays your apps & channels
5. **My App (*)**
6. **Directional button:** Helps navigate menus, content, etc.
7. **Select:** Confirms selections, enters sub-menus
8. **Back/Return:** Returns to previous menu screen, goes one step back, closes open windows, returns to main screen or **Home** tab
9. **Rewind:** Moves frames backwards in media such as movies, scrolls back a day in the channel guide
10. **Play/Pause**
Play: Starts to play selected media
Pause: Pauses the media being played
11. **Volume +/-:** Increases/decreases the volume level
12. **Stills:** Displays audio and subtitle options, where you can change the language preference and turn subtitles on or off (where available)
13. **Numeric buttons:** Switches the channel in Live TV mode, enters a number in the text box on the screen
14. **List:** Opens the channel list
15. **Last View:** Quickly cycles between previous and current channels and switches to Live TV mode
16. **Live:** Switches to Live TV mode to watch TV channels
17. **Programme +/-:** Increases/Decreases channel number in Live TV mode
18. **Mute:** Completely turns off the volume of the TV
19. **Fast forward:** Moves frames forward in media such as movies, scrolls forward a day in the channel guide
20. **Home:** Opens the Home screen. Press and hold to display quick settings menu
21. **Options:** Displays setting options (where available)
22. **Guide:** Displays the channel guide
23. **Voice button:** Activates the microphone on the remote
24. **Coloured Buttons:** Follow the on-screen instructions for coloured button functions
25. **Freeview Play:** Press to access Freeview Play Explore
26. **Netflix:** Launches the Netflix application
27. **Input:** Shows available broadcast and content sources
28. **Alexa LED:** Illuminates when the **Voice** button is pressed and during pairing process

Microphone opening: Speak into the microphone when using Alexa or voice search

(*) MY APP:

You can assign a shortcut to the My App button at any time by pressing and holding this button to quickly access apps, Alexa voice commands, and more. Follow the on-screen instructions.

Inserting the Batteries into the Remote

Remove the back cover to reveal the battery compartment on the back side of the remote control first. Insert two 1.5V - size **AAA** batteries. Make sure the (+) and (-) signs match (observe correct polarity). Do not mix old and new batteries. Replace only with same or equivalent type. Place the cover back on.

To pair remote with the TV

When TV is turned on for the first time, a pairing process for your remote will be performed during the initial setup. Follow the on screen instructions to pair it. If you experience difficulties pairing your remote with your TV you can turn off other wireless devices and try again. Refer to the **Remotes & Bluetooth Devices** section for detailed information on pairing new devices with your TV.

Initial Setup Wizard

*Note: Follow the on-screen instructions to complete the initial setup process. Use the directional buttons and the **Select** button on the remote to select, set, confirm and proceed.*

29. Choose Your Location

Select your location from the list and press **Select** to continue.

30. Choose Your Language

The language selection options will be listed on the screen. Select the desired language from the list and press **Select** to continue.

31. Select TV Mode

In the following step of the initial setup, you can set the TV's operation mode. **Store Use** option will configure your TV's settings for store environment. This option is intended only for store use. It is recommended to select **Continue** for home use.

32. Pair Your Remote with your TV

If your remote does pair with your TV automatically or if you have paired your remote with your TV once previously, this step will be skipped. If this is not the case, a search for your remote will be performed. Follow the on-screen instructions to pair your remote control (depends on the model of the remote control).

33. Connect to your network

Even if you did connect your TV to internet via an Ethernet cable before the initial setup begins the network connection will not be available automatically, you first have to enable it in this step. A confirmation dialogue will be displayed on the screen. You will be informed that the power consumption may increase and be asked for your consent to continue. Highlight **Enable** and press **Select** to proceed.

If you didn't connect your TV to internet via an Ethernet cable, your TV will search and list available wireless networks at this point after you enable network connection. Select your network and press **Select** to connect to it.

You can review or change the network settings later using the options in the **Settings > Network** menu. Refer to the **Network** and **Connecting to the Internet** sections if you need further information. Press **Fast Forward** button on your remote to skip.

After the internet connection is established, the TV will check for the software updates and download the latest software next, if any available. Please notice that this might take some time.

34. Sign In with Your Amazon Account

You can sign in to your Amazon account on the next screen. You need to be signed in to an Amazon account in order to use Amazon services. This step will be skipped if no internet connection has been

established in the previous step. If you don't already have an Amazon account you can set up an account by choosing **New to Amazon? Create a free account** option. You can press the **Fast Forward** button to skip this step. A dialogue will be displayed for confirmation. Highlight **Do this later** and press **Select** to continue. If you skip this step some of the following steps may differ or be skipped as well.

Once the account has been registered, you will be asked whether you want to use the account you signed in. You can choose to change the account, read the terms and conditions, which will be accepted if you continue, at this point. Highlight the symbol with three dots next to the texts at the bottom side of the screen and press **Select** to read and learn more about the related subject. Highlight **Continue** and press **Select** button to proceed without changing the account.

If you have connected your TV to internet via a WLAN network a dialogue will be displayed at this point, asking if you want to save your WLAN password to Amazon. Highlight **Yes** and press **Select** to confirm and proceed. Select **No** to proceed without confirmation.

35. Restore Fire TV

If you have previously used a Fire TV device, then you can choose to use the settings from that device for this TV. If you are new to Fire TV then highlight **Skip** and press **Select**.

To restore a previous Fire TV device highlight **Restore** and press **Select**. A list of your Fire TV devices will be displayed. Highlight the device of your choice then press **Select**. Your TV will now restore all the setting so that they match your other Fire TV device.

36. Freeview Play

Freeview Play screen will be displayed next. In order to make use of the related services highlight **Enable Freeview Play** and press **Select**. To skip, highlight **Do Not Enable** and press **Select**. By enabling Freeview Play, you accept the Freeview Play Terms of Use and acknowledge the Freeview Play Privacy Notice. To read and learn more about the Terms of Use, Privacy Notice, and Cookie Statement highlight the symbol with three dots next to the texts at the bottom side of the screen and press **Select**.

37. Prime Video

Depending on the selected location a brief information on the prime video services may be displayed next. You can start your 30 day free trial at this point. Highlight **Not now** and press **Select** to skip.

38. Select Apps

In the next step you can select the apps you want to download. Highlight **Get Started** and press **Select** to proceed. The apps are free to download but some of them may require payment for full access. Highlight **No Thanks** and press **Select** to skip.

39. Parental Controls

You can enable Parental Controls at this point or you can do it later.

Note that, if you choose **No Parental Controls**, purchasing and video playback without PIN will be allowed.

If you choose the **Enable Parental Controls** option, you will be asked to enter a PIN next. This is the Prime Video PIN and it is related to your Amazon account. Use the buttons on your remote as shown on the screen to enter the PIN. You will have to enter it to access some menus, services, content, etc. protected by this PIN. If you have forgotten your PIN follow the link shown on the screen to reset your PIN.

You will be informed about the feature on the next screen. Press **Select** to continue.

You can review or change the parental control settings later using the **Parental Controls** option in the **Settings > Preferences** menu.

40. What's New on Fire TV

You can get the latest news about TV shows, films, product news, special offers and more. Emails will be sent to the email address associated with your Amazon account. You can cancel your subscription at any time. To subscribe, select **Subscribe** or highlight **Skip** and press the **Select** button to skip.

41. Welcome to Fire TV

Brief information on the use of your Fire TV will be provided on the next screen. After reading press **Select** to continue.

42. Scan for TV channels

You will be asked whether you want to scan for channels in the next step. Highlight **Yes** and press **Select** to start the scan process. Highlight **No** and press **Select** to scan later.

Before the scan starts, you will be asked to check if your aerial is set up and your antenna cable is plugged properly into the antenna socket on your TV. Press **Select** to proceed.

43. Channel Type

The next step is the selection of the channel type. Select your scanning preference to install channels for Live TV function. **Terrestrial** and **Cable** options will be available.

After selecting an option, the TV will search for digital terrestrial or digital cable broadcasts. Select the searching method on the next screen and press **Select** to start search. If the **Cable** option is selected, press the **Play/Pause** button when complete.

While the search continues you can press the **Select** button to cancel. A dialogue will be displayed for confirmation. Highlight **Yes** and press **Select** to cancel.

When the initial setup is completed the results will be displayed. You can choose to make changes on the channel list or rescan at this point. Highlight **Done** and press **Select** to finish the setup.

Profile selection screen will be displayed next. You can select a profile, add a new one or edit profile settings. Highlight the profile you want to continue with and press **Select**.

Home screen will be displayed. In order to switch to Live TV mode and watch TV channels press the **Live** button on the remote (availability depends on the model of the remote). You can also select a channel from the **On Now** row in the **Home** tab or select the **Aerial** input option from the **Inputs** menu or **Inputs** row in the **Inputs** tab on the Home screen and press **Select** to start watching. Press the **Input** button to open the **Inputs** menu (availability depends on the model of the remote).

Main Screen

To enjoy the benefits of your Amazon Fire TV, your TV must be connected to the Internet. Connect the TV to a home network with a high-speed Internet connection. You can connect your TV wirelessly or wired to your modem/router. Refer to the **Network** and **Connecting to the Internet** sections for further information on how to connect your TV to the internet.

The main screen is the centre of your TV. Press the **Home** button on your remote to display the main screen. From the main screen you can start any application, switch to a TV channel, watch a movie or switch to a connected device, manage the settings. Depending on your TV setup and your country selection in the initial setup the main screen may contain different items.

The main screen is organised into several tabs. **Profiles**, **Inputs**, **My Stuff**, **Find**, **Home**, **Live**, recently used apps, **Your Apps and Channels** and **Settings** (gear wheel symbol) tabs will be available. You can scroll through them using the directional buttons. Available tabs may differ depending on the network connection status of your TV and whether you signed in to your Amazon account. Move the focus to the desired tab option to display the content. Available options of the highlighted tab will be positioned in rows generally. To navigate through the options use the directional buttons on the remote. Select a row then move the focus to the desired item in the row. Press **Select** button to make a selection or to enter a sub-menu.

The main screen will be opened with the **Home** tab. You can use the **Find** tab to search and find the content that you'll looking for. It has a dedicated search function where you can either press the Alexa Voice Button (if your remote has a built-in microphone) and ask Alexa to find what you're looking for or you can type a word

to start a search. Library will show any content that you have added to your Watchlist.

Live TV

Live TV refers to channels that have been tuned in via an aerial or cable connection. There are several ways to watch Live TV channels. You can press the **Live** button on the remote (availability depends on the model of the remote) to switch to Live TV mode and watch TV channels. You can also select a channel from the **On Now** row in the **Home** tab or select the **Aerial** input option from the **Inputs** menu or **Inputs** row in the **Inputs** tab on the Home screen and press **Select** to start watching. Press the **Input** button to open the **Inputs** menu (availability depends on the model of the remote).

If the channel installation is not completed the **On Now** row will not be available.

Customising TV Settings

Adjusting the Picture Settings

Allows you to set your preferred picture settings. You can access the picture settings menu via the **Settings** menu on the main screen or by pressing and holding the **Home** button for about 2 seconds while viewing any input.

Accessing Picture Settings via Settings Menu

Press the **Home** button, scroll to **Settings** tab. Scroll to **Display & Audio** option and press the **Select** button. Highlight the **Picture Settings** option and press the **Select** button. Scroll down to select the input that you want to adjust the picture setting of and press **Select** button. The TV will now change to the selected input. The **Picture Settings** menu will appear on the right hand side of the screen.

Accessing Picture Settings while watching the TV

While watching the input that you would like to adjust press and hold the **Home** button for 2 seconds. The quick settings menu will appear on the right hand side of the screen. Scroll down and highlight **Picture** then press **Select**. The picture setting options will appear on the right hand side of the screen.

Picture Menu Content

The following options show all the available picture setting adjustment on your TV.

Picture settings are input-specific and all of these settings will not apply to all Inputs. Some options may not be available depending on the input source.

Picture Mode: Set the picture mode to suit your preference or requirements. Picture mode can be set to one of these options: **Standard**, **Movie**, **Dynamic**,

Sport, **Game**, **PC** and **Customised**. You can also manually adjust each mode. Available options may differ depending on the currently set input source.

Backlight: Increases or decreases the brightness of the backlight from 0 - 100.

Dynamic Backlight: Set the Dynamic backlight to **On**, **Off** or **Eco**.

Colour Saturation: Adjusts the difference between light and dark levels in the picture. The range is from 0-100.

Screen Settings: The picture format can be set to **Automatic**, **16:9** and **4:3**.

Advanced Settings

Contrast: Adjusts the difference between light and dark levels in the picture. The range is from 0-100.

Brightness: Increases or decreases the picture brightness from 0-100.

Dynamic Contrast: Set the **Dynamic Contrast** to **On** or **Off**.

Local Contrast: Divides each frame to small regions and applies independent contrast curves for every distinct region. Local Contrast Control has 4 different setting **Off**, **Low**, **Medium**, **High**. Highlight your desired setting then press **Select**.

Gamma: Gamma can be changed between -4 and 4.

Tint: Increases or decreases the picture tint from -50 (greens) to 50 (reds).

Colour Temperature: Sets the desired colour temperature value. **Cool**, **Standard** and **Warm** options are available.

Sharpness: Adjusts the level of crispness in the edges between light and dark areas of the picture. Range is from 0-100.

MPEG NR: MPEG Noise Reduction has 4 different setting **Off**, **Low**, **Medium**, **High**. Highlight your desired setting then press **Select**.

Noise Reduction: Noise Reduction has 4 different setting **Off**, **Low**, **Medium** and **High**. Highlight your desired setting then press **Select**.

Natural Cinema: Set the Natural Cinema to **On** or **Off**.

Picture Reset: Resets all setting to factory default settings.

Adjusting the Sound Settings

Allows you to adjust the sound settings on your TV. You can access the sound settings menu via the **Settings** menu on the main screen or by pressing and holding the **Home** button for 2 seconds while viewing any input.

Accessing Audio Settings via Settings Menu

Press the **Home** button, scroll to **Settings** tab. Scroll to **Display & Audio** option and press the **Select** button. Scroll down to **Audio Settings** option and press the **Select** button. The sound setting options will appear on the right hand side of the screen.

Accessing Sound Settings while watching the TV

While watching the input that you would like to adjust press and hold the **Home** button for 2 seconds. The quick settings menu will appear on the right hand side of the screen. Scroll down and highlight **Sound** then press **Select**. The sound setting options will appear on the right hand side of the screen.

Sound Menu Content

The following options show all the available sound setting adjustment on your TV.

Dolby Mode: Dolby Audio has preset sound settings. The available options are **Standard**, **Music**, **Speech**, **Sport**, **Stadium**, **User** and **Off**. They are designed to give you the best sound quality for the content that you are viewing. Highlight your desired setting then press **Select**.

DTS Mode: This setting can only be accessed if **Dolby Mode** has been switched off. DTS Mode has 6 different setting **Standart**, **Music**, **Film**, **Clear Voice**, **Enhanced Bass** and **Flat**. The default setting is **Standart**. Highlight your desired setting then press **Select**.

Advanced Settings: Here you will be able to switch **Dialogue Clarity**, **TruVolume** and **DTS Virtual:X** on or off. Highlight the desired option and press **Select** to switch on or off. You can also configure your **Balance** and **Equaliser** settings.

Dialogue Clarity: Enhances signal clarity for clear dialogue that is audible above background sound effects.

TruVolume: Provides a consistent and comfortable volume level across content.

DTS Virtual:X: Reproduces elevated sounds and a cinematic surround sound image without surround speakers.

Dialogue Enhancer: This setting will only be available if the **Dolby Mode** option is not set to **Off**. **Off**, **Low**, **Mid** and **High** options will be available.

Volume Leveller: This setting will only be available if the **Dolby Mode** option is not set to **Off**. Allows you to balance the sound levels. **Off**, **Low**, **Mid**, and **High** options will be available.

Balance: Adjusts the sound level from the left and right speakers and can be adjusted from -25 to 25. The default setting is 0.

Equaliser: This setting can only be accessed once **Dolby Mode** has been switched off. Equaliser has 5 different settings: **100Hz**, **500Hz**, **1.5kHz**, **5kHz**,

10kHz. Each setting can be adjusted from -10 to 10, the default setting is 0 for all.

TV Speakers: Press **Select** to switch the TV speaker on or off.

Reset: Resets all settings to factory defaults.

Settings

If you need to change or adjust anything on your TV you'll be able to find the required setting in the **Settings** menu. You can access the **Settings** menu from the main screen of the TV. Press the **Home** button and scroll across to **Settings**. The settings menu is split into separate menus to make it easy for you to find what you're looking for.

Inputs

Use the **Inputs** menu to change between inputs and also select the **Media Player** from here if you have a USB Drive connected to one of the USB sockets.

Accessing the Inputs Menu

You can access the **Inputs** menu through the **Settings** menu on the main screen. Press the **Home** button to display the home screen, then scroll across to **Settings**. Press the down directional button to highlight **Inputs** and press **Select**.

You can also access input options from the **Inputs** tab on the **Home** screen or you can simply press the **Input** button to open the **Inputs** menu (availability depends on the model of the remote).

Selecting an Input

Press the left/right directional buttons to highlight your desired input then press **Select**. Your TV will now switch to that input.

Changing an Inputs Name

The input name can be changed for HDMI inputs. Highlight the input that you want to rename and press the **Options** button. Highlight **Change Device Name** and press **Select**. You'll now see a list of devices, highlight the one that you have connected and press **Select**. Then select **Next**.

If you want to set the inputs back to their original names, highlight the input, press **Option** and select **Reset Input**.

Media Player

If you have a USB storage device plugged into one of the USB sockets or you have files in Gallery you can access them and display them in the Media Player. The Media player allows you to display images, or play videos and audio files.

In the **Inputs** menu highlight **Media Player** and press **Select**. If this is the first time you have used the

Media Player, you may be asked whether you want to allow gallery to access photos, media and files on your device. Gallery is the name used for your TV so highlight **Allow** and press **Select**.

With Media Player open you'll see 4 tabs at the top of the screen, highlight **Your Files** to see all the files, **Videos** to see all videos, **Images** to see all images and **Audio** to see all audio files.

Under these tabs view options will be available. **View All** option and the folders which include media files will be listed. When you scroll across an option, only the media files in the highlighted folder will be displayed on the screen. Highlight the **View All** option to see all files.

Press **Options** button, highlight **Sort** and press **Select** to see available options to sort the files displayed on the screen.

If you have multiple images on your USB Drive you can create a slide show using your images. Highlight the **Images** tab at the top of the screen then press the **Options** button. From the **Options** menu highlight **Multi-select Images** and press **Select**. Now select the images that you would like to add into the slide show by highlighting each image and pressing **Select**. Once you have selected all the images press the **Play/Pause** button to start the slide show.

Once you have a slide show running you can change the setting of the slide show. Press **Options** button to see available options. You can set the **Album**, **Slide Style**, **Slide Speed** and **Shuffle** options according to your preferences. Adjust the settings then press the **Play/Pause** button to view your slide show.

Supported file Video formats: MPEG, MKV, MP4, MOV, 3GP and AVI.

Supported file Picture formats: JPEG, JPG, BMP and PNG.

Supported file Music formats: MP3 and WAV.

Notifications

The notifications menu shows you all the notifications about your TV. The notification symbol (a small bubble) will appear on the upper right corner of the gear wheel symbol on the **Home** screen to indicate that you have new notifications.

Reading Notifications

Highlight **Notifications** in the **Settings** menu and press **Select**. A small number in the small bubble on the upper right corner of the **Notifications** option indicates how many notification you have. All the available notifications will be displayed. Scroll across and highlight the notification that you want to read, then press **Select**. The notification message will be displayed on the screen.

Clearing Notifications

You can clear individual notifications or clear all of them. To clear an individual notification highlight the notification then press the **Options** button. In the **Options** menu highlight **Dismiss** and press **Select**. The notification will be deleted. To clear all the notifications press the **Options** button, highlight **Dismiss All** and press **Select**. All of the notifications will be deleted.

Managing Notifications

For the Appstore related notifications **Manage** option may be available. Highlight the notification and press the **Options** button. Highlight **Manage** and press **Select**. You will be directed to the **Notifications** setting option in the **Settings>Applications>Appstore** menu. Press **Select** to turn off the notifications related to Appstore.

Notification Settings

In order to configure the notification settings clear all notifications first. Press the **Options** button while **"No new notifications"** message is displayed on the screen, then highlight **Settings** and press **Select** to see available options. 2 options will be available. Use the **Do Not Interrupt** option to hide or show all application notification pop-ups. Use the **App Notifications** option to block or unblock notifications from individual apps.

Profiles

You can use the profiles menu to switch between the profiles associated with your account. You can also edit them and add a new profile if you wish. For more detailed configurations, you can use the **Profile Settings** option here to access the account and profile settings menu.

Account & Profile

The option to manage your Amazon Account settings may appear different depending on the registration status of the account. If you have registered with your Amazon Account the option will read **Account & Profile Settings**. Otherwise, it will read **Amazon Account Sign In/Up**. Here you can register/deregister your account or synchronise your purchased Amazon content.

Amazon Account

If you wish to remove your Amazon account from the TV you will need to deregister it. This will not delete your Amazon account it will just remove it from this TV. After deregistering your account this will remove content from your TV and many features will not work, until a new account is registered.

Highlight **Amazon Account** and press **Select**.

Then highlight **Deregister** and press **Select** to deregister your account. This will take a few seconds.

Important: Deregistering an account will NOT remove all personal data. To remove all personal data you will need to factory reset your TV. To do this go to **Settings > Device & Software > Reset to Factory Defaults**.

Once the account has been deregistered the **Amazon Account Sign In/Up** screen will be displayed so you can sign in using another account.

Sync Amazon Content

If you have purchased content such as movies, these can be viewed on other devices by synchronising Amazon content.

Highlight **Sync Amazon Content** and press **Select**. The word 'Synchronising' will appear. Your purchased content will now be viewable on other devices.

Prime Video

Information on where you can manage your subscriptions and transactions will be displayed.

Child Settings

Here you can manage child profile settings including adding content, setting time limits and managing your Child PIN.

Parental Controls

Your TV has some default protections which when enabled will require a PIN code to be entered for purchases, app launches and it will also restrict viewing of content rated Teen and above. Parental controls are set to **OFF** as default.

Highlight **Parental Controls** and press **Select** to switch parental controls on.

Note: You will be asked to enter a PIN to turn the parental controls on or off. This is the Prime Video PIN and it is related to your Amazon account. If you have forgotten your PIN follow the link shown on the screen to reset your PIN.

Profiles

Here you can manage the profiles associated with your account. Highlight **Profiles** and press **Select**.

Profile Sharing

Profile sharing allows Amazon Household adults to select each others profiles on Prime Video and Fire TV. Here you will find the site where you can change these settings.

Network

The Network menu has all the settings for connecting your TV to the internet. All the available networks will be shown here and this is where you can configure your network.

If you have connected your TV via an Ethernet cable or the **Enable Network** option is not set to **Off**, wireless networks will not be listed and wireless network related options will not be available.

Checking Network Status

Highlight **Network** in the **Settings** menu and press **Select**.

The Network menu will display the strongest 3 wireless networks your TV can find, your network is the one with the word 'Connected' written under it.

Highlight your network, if you're connected it will show **Connected** under the Network name. On the right of the screen it will show the **Security** of your connection. With your network highlighted press the **Play/Pause** button to check your network. You will see connection status of your network. Press the **Back** button to exit this screen. If you want to forget the network press the **Options** button while your network is highlighted.

Seeing All Networks

If you want to search for more networks, highlight **See All Networks** and press **Select**. You will now see a list of all the networks that your TV can find. If you scroll down to the bottom of the list you also have the option to rescan for networks.

Joining a Network Using WPS Button or PIN

If you can't remember your WLAN password using the WPS option temporarily disables your routers password and allows you to connect to it without it.

Highlight your preferred WPS connection option and press **Select**, then follow the on-screen instructions.

Advanced Network Settings

If you are confident in using network setting you can manually setup a network by highlighting **Join Other Network** and pressing **Select**. You will have to manually type in all your desired network settings using the on-screen keyboard.

If you have connected your TV via an Ethernet cable you can also configure your network setting. This is also a more advanced setting for users that are confident in setting up networks.

Saving your WLAN Password to your Amazon Account

Your WLAN password can be saved to your Amazon Account, this can be helpful if you would like to connect other devices to the same network. The default setting is **Off**.

Highlight **Save Wi-Fi Passwords to Amazon** and press **Select**. Your WLAN password will now be saved in your account. It can be deleted at any time by turning this option off.

Turning on your TV via LAN and WLAN

Enable devices and apps that you select to turn on your TV via LAN and WLAN. Turning this option on may increase your TV's power consumption.

If you enable network connection this option will also be enabled automatically. Highlight **Turn on with LAN and Wi-Fi** and press **Select** to disable.

Changing Connection Status

If you did not enable the network connection during the initial settings process, you can use this option to enable it. Or you can disable it if you enabled priorly.

Highlight **Enable Network** and press **Select** to enable or disable the network connection. Refer to **Connecting to the Internet** section if you need more information.

Basic Wi-Fi Troubleshooting Tips

Here you can view tips like these and restart your Fire TV. Highlight **Basic Wi-Fi Troubleshooting Tips** and press **Select**.

Display & Audio

This menu houses all the settings and adjustments for your picture and sound as well as other settings such as, how your TV powers on, screen mirroring, screen saver setting and HDMI CEC device control.

Highlight **Display & Audio** in the **Settings** menu and press **Select**.

Picture Settings

Picture settings can be adjusted on each input, so each input can be set to have its own picture settings. For information on adjusting each setting refer to the **Customising TV Settings** section of this manual.

For adjusting picture setting while viewing your TV, press and hold the **Home** button and select **Picture** in the menu on the right hand side of the screen.

Audio Settings

Sound settings can be adjusted here, for information on adjusting each setting refer to the **Customising TV Settings** section of this manual.

For adjusting sound settings while viewing your TV, press and hold the **Home** button and select **Sound** in the menu on the right hand side of the screen.

Apple AirPlay & HomeKit

Stream from your Apple devices and control content with Apple AirPlay & HomeKit. You will be redirected to Apple AirPlay & HomeKit settings for setup and configuration.

Power Controls

The Power Control menu has 2 options: **Power On** and **Voice Commands When TV Screen is Off**.

Power On: The Power On setting allows you to choose which state you want your TV to switch on in, either the last input that you were watching or the Home screen.

Highlight **Power On** and press **Select**. Highlight **Home** or **Last Input** and press **Select**. A tick will appear next to your choice.

Voice Commands When TV Screen is Off: When enabled, you can give voice commands through a linked Alexa or Apple HomeKit-enabled device when your TV screen is off. Your TV screen will turn on to complete voice commands. Highlight this option and press **Select**. Select **Yes** and press **Select**.

Audio Output

The Audio Output menu has 6 options: **TV Speakers**, **Audio output jack**, **Digital Audio Format**, **DTS DRC** and **Bluetooth Audio Sync**.

Highlight **Audio Output** and press **Select**.

TV Speakers: In the TV Speakers menu you can switch your TV's built-in speakers on or off. You may wish to switch them off if you have connected a soundbar.

Highlight **TV Speakers** and press **Select** to switch the TV Speakers on or off.

Audio output jack: For 3.5 mm audio jack in back of TV. Select fixed for line output or variable for headphone.

Digital Audio Format: Depending on the type of audio device you have connected you may need to adjust the audio format that your TV outputs. The audio format can be changed here.

Highlight **Digital Audio Format** and press **Select**.

Highlight your desired audio format **PCM**, **Dolby Audio**, **Pass-through** and **Auto** then press **Select**. The default setting is **Auto**.

DTS DRC: The DTS DRC menu enables DTS DRC to be switched on or off.

Highlight **DTS DRC** and press **Select** to switch the DTS DRC on or off.

Bluetooth Audio Sync: If you have a Bluetooth speaker or headphones connected to your TV you might need to sync the audio to your device. Selecting this option will do this for you.

With your Bluetooth device connected to your TV highlight **Bluetooth Audio Sync** and press **Select**.

Enable Display Mirroring

Enable mobile devices to temporarily mirror their display to your TV, by making it discoverable. This

referred to as Display Mirroring or Miracast on your device.

Highlight **Enable Display Mirroring** and press **Select**. **Display Mirroring** screen will be displayed. Your TV is ready now for display mirroring.

Navigation Sounds

While navigating menus and selecting items your TV will make a sound, this can be switched on and off here.

Highlight **Navigation Sounds** and press **Select** to switch them on or off.

Screen Saver

When your TV is inactive for a few minutes the screen saver will activate. Pictures from the Amazon Collection will play. The screen saver menu gives you many options to change so that you can customise your screen saver. If your TV is not connected to the internet **Screen Saver** option will not be available.

Highlight **Screen Saver** and press **Select**.

The **Screensaver Settings** menu will appear.

Current Screen Saver - Here you can change the screen saver album so it shows your pictures.

Slide Style - Change the way the pictures transition. Choose from **Pan & Zoom** or **Dissolve**.

Slide Speed - Adjust the time taken to change pictures. Choose from **Slow**, **Medium** or **Fast**.

Start Time - Set the time taken before the Screen Saver starts. Choose from **5**, **10**, **15 minutes** or **Never**.

Date and Clock - Switch the date and clock information on or off.

Display Info - Switch the picture information on or off.

Alexa Hints - Switch the Alexa hints on or off.

Shuffle - Switch this option on if you want to display pictures in a random order.

HDMI-CEC Device Control

Allows your TV to control connected CEC-capable HDMI devices using your TV remote.

Playback, navigation and power on/off can all be accomplished via a single TV remote. Press **Select** to switch on or off.

If you have a CEC enabled device connected to your TV via a HDMI cable, this setting allows your TV remote control to also control selected functions of your connected device. For example the **Standby** button on your TV remote will also switch on your CEC enabled device.

The HDMI-CEC Device Control menu has 4 options: **One-Touch Play**, **ARC**, **Power Control** and **Remote Control Pass-Through**.

Highlight **HDMI-CEC Device Control** and press **Select**.

One-Touch Play: Use your TV as the primary source for playback. Highlight **One-Touch Play** and press **Select**. **Allow**, **Always Ask** and **Deny** options will be available. Highlight your desired option then press **Select**.

ARC: Use your HDMI cable connection to send audio from your TV to your soundbar or AV receiver. Highlight **ARC** and press **Select** to switch the on or off.

Power Control: Use your TV to turn on/off connected devices. Press **Select** to switch on or off.

Remote Control Pass-Through: Use your TV remote to control devices from other inputs. Press **Select** to switch on or off.

Preferred Live TV Language

Select your preferred primary or secondary audio and subtitle language for Live TV channels.

Subtitles

Enable or disable subtitles. If subtitles are enabled you can further choose your preferred subtitle languages.

Spoken Subtitles

Enable automatic playback of spoken subtitles in addition to main audio if available for current program.

Audio Description

Low volume, **Medium volume**, **High volume** and **Off** options will be available. Select **Off** to disable audio description or any other option to enable it. Certain programmes offer the possibility of choosing the volume of the audio description voice over. For such programmes your choice of volume will be automatically applied.

Hybrid TV (HbbTV)

Enable or disable red button interactive applications (HbbTV) on TV or radio channels.

"Do not track" request

Send "Do not track" requests while using red button applications (HbbTV). When enabled, this option enhances your privacy protection; however certain applications may offer limited content or functionality when this option is enabled.

Low signal strength alert

Enable or disable low signal strength alert.

Applications

The applications menu lets you manage all your apps. Highlight **Applications** and press **Select**.

Amazon Photos

Here you can change the Amazon photo app settings, you can allow others to cast photos from their Amazon

Photos account to your TV, and you can also disable your account so it can't be viewed on your TV.

Highlight **Amazon Photos** and press **Select**.

Allow Guest Connections is switched on as default, if you don't want to allow other users to cast photos from their Amazon Photo accounts you can switch this feature off. Highlight **Allow Guest Connections** and press **Select** to switch the feature on and off.

If you want to stop seeing your photos from your Amazon Photos account you can disable the feature here. Access is enabled as default. Highlight **Access Amazon Photos** and press **Select**. Highlight **Disable Amazon Photos** and press **Select**. Your photos will now not be viewable on your TV. Don't worry your photos will not be deleted they will remain in your account.

Silk Browser

Configure the settings of the Amazon web browser.

Appstore

This menu allows you to control your app setting such as auto updates, in-app purchases and how to open external market links.

Highlight **Appstore** and press **Select**.

The Appstore menu will be displayed where you can select the following:

Automatic Updates: When automatic updates are enabled Appstore will automatically update your apps to the latest versions. If the permissions of the app are altered they will not be automatically updated, so you will review any changes before agreeing and updating. Press **Select** to switch on or off.

External Market Links: Gives you the choice of how you want external links to open. Press **Select** to see the available options: **Open with the Amazon Appstore**, **Don't Open** and **Ask Before Opening**. Highlight the option you prefer and press **Select**. A tick will appear next to your choice.

In-App Purchases: Some apps have in-app purchases that can be made, this setting lets you choose if you want to allow them or not.

Press **Select** to switch on or off.

Manage My Subscriptions: You can manage your subscriptions online.

Follow the link shown on the screen.

Notifications: Set to **ON** to display notifications relating to Appstore. Press **Select** to switch on or off.

Manage Installed Applications

Here you can manage all the apps on your TV. It will also show you the amount of available memory left on your TV. Highlight **Manage Installed Applications** and press **Select**.

The default setting is for it to show all apps, however if you highlight **Show** and press **Select** you get the options to show **All Applications**, **Internal Only** or **USB Only**.

A list of apps will be displayed, highlight the app that you'd like to manage and press **Select**.

Pre-installed apps have 3 options, apps that you have downloaded and installed have more options. If you uninstall an app it will still be available for you to download and re-install again in the future.

Pre-installed apps

You will have 6 options **Force stop**, **Clear data**, **Clear cache**, **Clear Defaults**, **Open supported links**, and **Supported Links**.

Installed apps

You will have some extra options: **Permissions**, **Launch application** and **Uninstall**.

Equipment Control

Soundbars and receivers can be connected to your TV and here they can be setup so that your Fire TV remote can control the connected device no matter how you connected it to your TV. This process might take some time.

Adding a Soundbar or Receiver

Highlight **Add Equipment** and press **Select**.

Highlight either **Soundbar** or **Receiver** depending on the product that you have connected then press **Select**.

Note: Make sure your soundbar or receiver is connected to your TV and switched on.

The following example shows how to setup a soundbar. Now you need to select the brand of your soundbar. Highlight the brand then press **Select**.

Make sure your soundbar is switched on and the volume is up then press **Select**.

Press **Standby** on your TV remote control, wait 10 seconds then press the **Standby** button again.

You'll now be asked 'Did your soundbar turn off and then back on when you pressed **Standby**'. If it did highlight **Yes** and press **Select**, if it didn't highlight **No** and press **Select**. You may need to repeat this process multiple times.

When your soundbar eventually turns off and on, you will be asked to press the volume up and down buttons. Press the **Volume +** and **-** buttons.

If your volume level adjusted as expected highlight **Yes** and press **Select**. If not select **No** and continue until the volume level changes.

Your Fire TV remote has now been setup, it will now switch your soundbar on and off and adjust the volume level.

Now when you switch your TV on your soundbar will also switch on. The TV speakers will be automatically switched off.

Soundbar/Receiver Settings

Once you have setup your soundbar or receiver you will now see either **Soundbar** or **Receiver** in the **Equipment Control** menu. This will show you all the settings for your device.

Highlight **Soundbar** or **Receiver** and press **Select**. You will now see a list of settings.

Highlight the setting that you wish to adjust and press **Select**.

Volume Increments: Set the amount the volume increases or decreases when you ask Alexa to change the volume. The default increment is set to 4.

Press **Fast Forward** or **Rewind** to increase or decrease the increments. Press **Option** to restore back to default settings.

Infrared Options: Changes the infrared options. **IR Profile**, **Timing**, **Repetition** and **IR Controller** options will be available.

Power Controls: Adjusts the power on/off settings for your soundbar or receiver. **Power On Delay** and **Power Control** options may be available.

Fire TV Input: Change the input, to which your soundbar or receiver will switch to for watching Fire TV.

Change Soundbar/Change Receiver: If you would like to change the soundbar or receiver that's connected to your TV highlight **Change Soundbar/Change Receiver** and press **Select**. To remove the device highlight **Change Soundbar/Change Receiver** and press the **Option** button.

Restore Soundbar Defaults/Restore Receiver Defaults: Restores all the settings that you may have changed back to factory defaults. This option will be available if you change the default settings.

Advanced Settings

Adjust the power timing if your soundbar or receiver does not switch on/off.

Press **Fast Forward** or **Rewind** to increase or decrease the increments.

Press **Option** to restore back to default settings.

Live TV

This menu allows you to tune in your TV, manage the channels, set up a CI card and set parental controls.

Highlight **Live TV** and press **Select**.

Channel Scan

You should have already tuned in your TV during the initial setup process. But if you skipped the channel

scan step or if you need to retune your TV follow these instructions.

Highlight **Channel Scan** and press **Select**.

You will be prompted to check that your aerial is set up and that the cable is plugged properly into the antenna input socket on your TV. Press **Select** to proceed.

Select your scanning preference to install channels. **Terrestrial** and **Cable** options will be available.

If the **Terrestrial** option is selected, the TV will search for digital terrestrial broadcasts. Select the search method on the next screen and press **Select** to start the search. If you continue with the manual scan, you will need to configure the **Frequency** and **UHF Band** options before starting the scan.

If the **Cable** option is selected, the TV will search for digital cable broadcasts. On the next screen, select the cable provider, if any available, or the search method, then press **Select** to start the search. You may need to configure the **Network ID** and **Frequency** options before starting the scan.

When you are finished, press the **Play/Pause** button. The TV will start to search available broadcasts.

You will be asked at some point whether you want to clear existing channels, if you have installed channels previously using the same search option. Highlight **Yes, Clear Channels** and press **Select**. All the previously tuned in channels will be deleted. Highlight **No, Keep Channels** and press **Select** to proceed without clearing existing channels.

While the search continues you can press the **Select** button to cancel. When the search is completed the results will be displayed. You can choose to make changes on the channel list or rescan at this point. Highlight **Done** and press **Select** to finish the setup.

Automatic Service Update

You can allow your TV to automatically scan for network operator changes when TV enters standby mode. Press **Select** to turn this feature on and off.

Favourite Channels

You can view and manage your favourite channels here.

Highlight **Favourite Channels** and press **Select**.

If you do not have any favourite channels go to **Manage Channels** menu to add channels by pressing the **Select** button. Then select the channel source to view the channel list. Highlight a channel and press **Select** to add this channel to your favourites. You can make multiple selections.

If you have priorly added channels to your favourites you can press **Select** to select the channels you want to remove from your favourites.

Manage Channels

Manage your favourite channels and select the channels you want to display.

Highlight **Manage Channels** and press **Select**. Then select the channel source. **Terrestrial Channels** and **Cable Channels** options will be available. Available options may differ depending on the currently installed channels.

You will now see the channel list with several tabs: **All**, **Favourites**, **Free**, **Encrypted**, **Audio**, **HD**, **SD**, and **Hidden**. Available tab options may differ depending on the installed channels.

All will show all the channels, **Favourites** will show all the channels you marked as favourite channels and **Hidden** will show all the hidden channels. Other tabs will work according to the same logic.

In the **All** tab you can choose to add a channel to the favourites list by pressing **Select** or you can hide a channel by pressing **Play/Pause**. To change the channel number press **Rewind** and to move a channel from the channel list press **Fast Forward**. Press the **Options** button to view the **Sort Options** menu. You can sort the channels using the options of this menu. You can also import or export the customised channel list using the relevant options in the **Sort Options**>**Advanced Options** menu.

CI Card

Access your CI Card settings and information.

Parental Controls

Restrict over-the-air films, TV shows, purchasing and certain types of content.

Highlight **Parental Controls** and press **Select**.

The default setting is **Off** so press **Select** to switch on.

Note: You will be asked to enter a PIN to turn the parental controls on or off. This is the Prime Video PIN and it is related to your Amazon account. If you have forgotten your PIN follow the link shown on the screen to reset your PIN.

The first time you enable **Parental Controls** you'll see some brief information about the settings. Press **Select** to continue.

You'll now see all the settings that can be adjusted. Highlight your desired setting and press **Select**.

Parental Controls: Press **Select** to switch parental controls on or off.

PIN-Protect Purchases: Asks for a PIN before any video, apps or games purchases. Press **Select** to turn on or off.

Prime Video Ratings: Restricts viewing of videos based on ratings. The default setting for **General** and **Family** rating is On, for **Teen**, **Young Adults** and **Mature** ratings is Off. Highlight the desired rating option and press **Select** to change the setting.

Note: These settings apply to Prime Video (including Amazon Channels). Content from other service providers may have their own restriction settings.

Broadcast Ratings: Use ratings to restrict the viewing of Live TV programmes from over-the-air broadcast TV accessed directly from the Fire TV user interface, such as **Guide** or **On Now** row. Visit third-party apps to manage settings for content accessed within those apps.

- DVB 4 (Child) - DVB 18 (Adult)

- All settings are switched on by default

PIN-Protect App Launches: Asks for a PIN before launching apps and games. This setting will not apply to the content accessed directly from the Fire TV user interface, such as the **Guide** or **On Now** row. Press **Select** to turn on or off.

PIN-Protect Amazon Photos App: Asks for a PIN before launching Amazon Photos. This setting will be ignored if you have already set **PIN-Protect App Launches** to **ON**. Press **Select** to turn on or off.

Change PIN: Change the Prime Video PIN. First enter your current PIN, then enter your new PIN.

If you have forgotten your PIN follow the link shown on the screen to reset your PIN.

Sync Sources

Sync your Live TV sources to refresh the data on this device.

Remotes & Bluetooth Devices

You can add extra voice remote to your TV, or you may also need to replace one if your old one broke. Other bluetooth devices like speakers, games controllers, mice and keyboards can also be connected via bluetooth.

Voice Remotes with Alexa

Check the status of your current voice remote with Alexa or add a new one.

Highlight **Voice Remotes with Alexa** and press **Select**.

Remote Status

To see the status of your current voice remote highlight the remote option and look at the right hand side of the screen. You will see the type of remote control, the battery status, the version number and its serial number.

To unpair the remote press the **Options** button while the remote option is highlighted then press **Select** to confirm. The **Options** button will have no function if only one remote is paired.

Add New Remote

Highlight **Add New Remote** and press **Select**.

You'll see the word 'Searching' appear, press and hold the **Home** button on the new remote control for 10 seconds. When the remote has been discovered it will appear in the list.

Game Controllers

Bluetooth gaming controllers can be connected to your TV which can be used to enjoy all the gaming apps on your TV.

Highlight **Game Controllers** and press **Select**.

Highlight **Add New Game Controller** and press **Select** to search for new controllers.

You'll see the word 'Searching for Controllers' appear on the right hand side of the screen. Make sure your controller is discoverable and ready to pair. Follow the on-screen instructions. When the controller has been discovered it will appear in the list. Select your controller from the list.

Other Bluetooth Device

You can connect other bluetooth devices such as a mouse or a keyboard, which can be handy when using the internet browser.

Highlight **Other Bluetooth Devices** and press **Select**.

Make sure your bluetooth device is in pairing mode and then highlight **Add Bluetooth Devices** and press **Select**.

Your device will appear in the list, this could take a minute or so. Then highlight the device and press **Select** to connect the device.

Alexa

This menu has more information about the Alexa app and examples of things to try.

Highlight **Alexa** and press **Select**.

Alexa App

To find out more information about the Alexa application and where to download it select **Alexa app**. You will need this app if you want to let your Amazon Echo speakers control your TV. The app is the place where you'll be able to connect all your Amazon devices together.

Highlight **Alexa app** then press **Select**, you will now see information about the application and where to download it.

Things to Try

For lots of examples of what you can use Alexa for, look in this section. You will find many ideas.

Highlight **Things to Try** then press **Select**, you will see a list of things to try.

Highlight something in the list and then press **Select** to see more information.

Preferences

The preferences menu is where you'll find adjustment to lots of the settings on your TV. Things like parental controls, privacy and data setting and restricting access to certain content and purchases.

Highlight **Preferences** and press **Select**.

Parental Controls

Your TV has some default protections which when enabled will require a PIN code to be entered for purchases, app launches and it will also restrict viewing of content rated Teen and above. Parental controls are set to **OFF** as default.

Highlight **Parental Controls** and press **Select** to switch parental controls on.

***Note:** You will be asked to enter a PIN to turn the parental controls on or off. This is the Prime Video PIN and it is related to your Amazon account. If you have forgotten your PIN follow the link shown on the screen to reset your PIN.*

Refer to **Parental Controls** section under the **Live TV Menu** title for more information.

Privacy Settings

You can manage all of your TV's privacy settings here. Highlight **Privacy Settings** and press **Select**.

You will now see a list of all the settings that can be adjusted, highlight the setting that you would like to adjust and press **Select**. The possible settings are as follows.

Cookie consent: Allows use of cookies, device identifiers and similar tools to enhance your advertising experience on this Fire TV device. Visit amazon.co.uk/deviceprivacy to make more detailed choices.

Device Usage Data: Allows use of personal data collected by operating system of this TV for marketing and product improvement purposes. The default setting is **ON** (Allow). Highlight and press **Select**. You will be informed about this feature. Use directional buttons to read the entire text. To turn this feature off highlight **Turn Off** and press **Select**.

Collect App and Broadcast Usage Data: Allows Amazon to collect information relating to your use of broadcast TV content, as well as the frequency and duration of your use of third-party apps. The default setting is **ON** (Allow). Highlight and press **Select**. You will be informed about this feature. To turn this feature off highlight **Turn Off** and press **Select**.

Interest-based Ads: If you opt out of interest-based ads on your TV, apps will be instructed not to use the advertising ID to build profiles for advertising purposes or target you with interest-based ads on your TV. The advertising ID is a resettable identifier that can be used to build profiles or show you interest-based ads. The default setting is **ON** (Allow). To turn this feature off press **Select**.

Your Advertising ID: Shows your Advertising ID on the right hand side of the screen. Press **Options** button to reset your ID. A confirmation dialogue will be displayed. Highlight **OK** and press **Select** to reset. This option will be available if the **Interest-based Ads** option is set to **ON**.

Data Usage Monitoring

You can manage all your data usage here.

Highlight **Data Usage Monitoring** and press **Select** to switch on and adjust any settings. Data monitoring is set to **OFF** as default.

Data Usage Monitoring: Switching on allows you to monitor your data consumption. The default setting is **OFF**.

Set Video Quality: This allows you to choose the video quality on Amazon Video. The default setting is **Best**. Available options are **Good** (least amount of data used), **Better** and **Best** (most amount of data used).

Set Data Alert: Set a data limit and receive on-screen alerts when consumption reaches 90% and 100% of the limit. This is just an alert and will not block data consumption.

Monthly Top Data Usage: Displays a list of your apps and shows individual data usage for the monthly billing cycle specified in the **Set Data Alert** option.

Notification Settings

You can manage all your notifications here, turn off all notification pop-ups or block/unblock notifications from specific apps.

Highlight **Notification Settings** and press **Select**.

To switch on/off notification pop-ups highlight **Do Not Interrupt** and press **Select**.

To block or unblock notifications from individual apps, highlight **App Notifications** and press **Select**. You'll see a list of your apps, it will show if notifications are on or off. To adjust this highlight an app and press **Select** to switch between **ON** and **OFF**.

Featured Content

The Home screen has featured content at the top, when you select this content it will play a preview of the content. In this menu you can choose if the content plays or not and also switch the audio of this content on and off.

Highlight **Featured Content** and press **Select**.

Highlight either **Allow Video Autoplay** or **Allow Audio Autoplay** and press **Select** to switch the feature on or off. The default setting is **ON** for both.

Allow video autoplay

ON - The video will automatically play.

OFF - A still image will appear and no audio will be heard.

Allow audio autoplay

ON - Audio will be heard when the video plays.

OFF - No audio will be heard when the video plays.

Auto Turn Off

Your TV will automatically switch off after 4 hours of no activity. This feature is to help save energy if your TV was accidentally left on. If you have been watching your TV for 4 hours without pressing any buttons, a warning will appear telling you its about to turn off. If you wish to continue watching at this stage highlight **OK** and press **Select**.

To switch off this feature, highlight **Auto Turn Off** and press **Select**. Then highlight **Turn Off** and press **Select**. Your TV will now not switch off after 4 hours of inactivity.

HbbTV

Enables Hybrid Broadcast Broadband TV on your TV. Highlight **HbbTV** and press **Select** to switch on or off.

Sync Recent Content

You can include Prime Video titles watched on other devices in the **Recent** row on this device.

Highlight **Sync Recent Content** and press **Select** to switch this feature on or off.

Location

Its handy that your TV knows where it is in the world so when you ask Alexa a question like 'Alexa, what's the weather outside?' it can tell you the weather in your location. Download and install the Alexa app on your mobile device, then select **Device > Echo & Alexa**. Select your Fire TV from the list, then enter your device's location.

Time Zone

In this menu you can set your clock to display as a 24 hour clock and you can also change your time zone.

Highlight **Time Zone** and press **Select**.

To switch 24 hour time format on/off highlight **24-Hour Time** and press **Select**.

To change your time zone, highlight **Time Zone** and press **Select**.

Sync Date and Time

Your TV will automatically synchronise date and time with an internet time server. If you switch this feature off your TV will sync with broadcast time. This may result in network connection and playback issues. You must restart your Fire TV if you choose to switch this feature on again.

Highlight **Sync Date And Time** and press **Select** to switch it on or off.

Language

You can change the system language.

Highlight **Language** and press **Select**.

Choose your desired language from the list of languages and press **Select**.

Metric Units

This option will be set to **ON** by default. Temperatures and distances will be displayed in metric units.

Highlight **Metric Units** and press **Select** to switch on or off.

Freeview Play

Switching Freeview Play on allows your TV to discover fresh live and on demand shows from UK broadcasters, all together in one place. Freeview Play requires an internet connection.

Highlight and press **Select** to switch on or off. When switching on you will be informed about this feature. Highlight **Enable** and press **Select**.

Sleep Timer

The sleep timer function lets you set a countdown to when your TV will switch off, so that you can fall asleep while watching TV knowing it will automatically switch off. You can set a countdown from 5 - 240 minutes.

Highlight **Sleep Timer** and press **Select**.

Highlight the amount of time you want until your TV switches off and then press **Select**.

A countdown will start in the bottom corner of the screen. You can also switch off the countdown by highlighting **Off** and pressing **Select**.

Note: The TV will switch off once the sleep time has elapsed, no warning will be shown.

Device & Software

This menu will give you information about your TV, show you legal and compliance documents. You can also restart or reset your TV back to factory defaults.

Highlight **Device & Software** and press **Select**.

About

If you need to find out any information about your TV it should be displayed here. You'll also see storage and network information and you will also be able to check for any available software updates.

Highlight **About** and press **Select**.

Your TV: Displays information related to your TV.

Storage: Shows the available storage space on your TV and on any external device that's connected.

Network: Displays all the information related to network setting.

Check for Updates: Displays your current software version and when it was last updated. Press **Select** to check for any new updates. If an update is available this option will appear as **Install Update**. In this case, you can press **Select** to install the update.

USB Drive

This menu will show you the available space on your drive. You will also be able to eject the drive or manage installed applications. This menu will only appear if you have a USB drive connected.

Highlight **USB Storage Status**. The space available will be shown on the right hand side of the screen.

Eject USB Drive

Highlight **USB Drive** and press **Select**.

Then highlight **Eject USB Drive** and press **Select**. Now remove your drive from the USB socket. The menu will return back to the **Device & Software** root menu.

Formatting a USB Drive

Important: Formatting the USB drive will erase all information on the USB drive. Once formatted this USB drive can only be used by this TV.

Select this option if you intend your TV to use apps stored on this drive.

Highlight **Format to Internal Storage** then press **Select**.

When formatting is complete select **OK**.

Manage Installed Applications

Select this option to manage installed applications from both Amazon and other sources.

Legal & Compliance

To read all the legal and compliance notices regarding your TV select this menu.

Highlight **Legal & Compliance** then press **Select**.

Note: Your TV will need to be connected to the internet to access Legal & Compliance information.

Sleep

Your TV can be put to sleep.

Highlight **Sleep** then press **Select**. Your TV will go to sleep. You can wake it up again by pressing the **Standby** or **Select** button.

Restart

If for some reason your TV is slow or locking up you may want to restart it. This will re-boot your TV.

Highlight **Restart** then press **Select**. Confirm you want to restart by selecting **Restart** and then press **Select**. Your TV will now restart, this will take a few seconds.

Reset to Factory Defaults

If you want to totally reset your TV select **Reset to Factory Defaults**. This will remove all personal data

and downloaded content from your TV. You should do this if you sell your TV or give it to someone.

Highlight **Reset to Factory Defaults** then press **Select**. Confirm you want to reset by selecting **Reset** and then press **Select**. Your TV will now reset itself back to the state it left the factory. This process will take a few minutes.

Accessibility

This menu has accessibility options where you can switch on **Subtitle**, **Alexa Subtitles**, **VoiceView**, **Text Banner**, **Screen Magnifier**, **High-Contrast Text**, **Audio Description**, **Spoken Subtitles for Broadcast Channels** and **Feedback & Support**.

Highlight **Accessibility** and press **Select**.

Subtitle

Displays subtitles on all video content when available. Press **Select** to switch subtitles on and see more options.

Alexa Subtitles

Displays subtitles for Alexa responses when available. Press **Select** to switch subtitles on and see more options.

VoiceView

Provides spoken feedback as you navigate items on the screen. Manage voice guidance settings including turning **VoiceView** on and off, reading speed and volume.

Text Banner

Displays text related to the focused item in a box with customisable font size, colours and more. Toggle the text banner on and off.

Screen Magnifier

Enables the use of button combinations to magnify the screen. Only for use when viewing the Home screen or menus.

Highlight **Screen Magnifier** and press **Select**.

The button combinations will be displayed. Highlight **OK** and press **Select** to continue. Highlight **TURN OFF MAGNIFIER** and press **Select** to turn it off.

You can also press and hold the **Back** and **Fast Forward** buttons to activate/deactivate screen magnifier.

Once the magnifier is activated you will see a yellow box at the top of the screen. Press **Options** button and a directional button at the same time to pan around the screen.

High-Contrast Text

Changes text to black or white and adds a border.

Audio Description

This setting controls the volume of the descriptive track related to the normal track for over-the-air channels and Prime Video content.

Highlight **Audio Description** and press **Select**.

Highlight the option you want and press **Select** to set. You can set **Over-the-Air Channels** option to **Off**, **Low**, **Medium** or **High** and the **Prime Video** option to **ON** or **OFF**.

Spoken Subtitles for Broadcast Channels

Speaks subtitles of supported broadcast content. Press **Select** to turn it on or off.

Feedback & Support

Your suggestions are important and help us improve the accessibility of Fire TV. Please e-mail us at device-accessibility@amazon.com, and mention you are using a Fire TV.

If you need help now, please contact Amazon customer service.

Help

If you are struggling to understand how your TV work and you need a little help then you should take a look at this menu. It will show you helpful videos and quick tips about your TV. It will also give you contact details for getting support about any issue you have.

Highlight **Help** then press **Select**.

Help Topics

Your TV has helpful videos that you can watch to help you understand how to use your TV.

Note: New helpful video will be added every time your TV updates, so the amount of content here will change from time to time.

Get More Help

If you feel you need more help with your TV, select the related section where you will find details of how to get in touch with a support team.

Highlight **Have Us Call You** and press **Select**.

Suggestions

Highlight **Send Feedback** to display information on where you can send us feedback about your Fire TV experience.

Channel List

The TV stores and shows all channels in the channel list. When a TV channel is turned on in Live TV mode programme information will be displayed. You can also press the **Live** button (availability depends on the model of the remote) to display programme information. Press the Down directional button to see the channel list. You can press the Left and Right directional buttons to scroll through the list.

Use the directional buttons and the **Select** button to navigate the channel list, change channel and view additional information on programmes.

Press the Down directional button twice when the channel list first appears to see the options menu. You can set the subtitle and audio preferences and access the channel guide using the related options of this menu.

Refer to **Channel Guide** section for information on managing channels.

Channel Guide

By means of channel guide function of your TV you can browse the event schedule of the currently installed channels on your channel list. It depends on the related broadcast whether this feature is supported or not.

In order to access the channel guide press the **Guide** button on the remote.

Use the directional buttons to navigate through the channel guide. You can use the Up/Down directional buttons to switch to previous/next channel on the list and Right/Left directional buttons to select a desired event of the currently highlighted channel. If available, the full name, start-end time and date of the highlighted event and a brief information about it will be displayed on the screen.

Browse & Filter

The Guide has options in the **Browse & Filter** menu where you can filter channels or highlight programmes that have subtitled, audio description or signed options and highlight programmes by genre.

Use the directional buttons to highlight **Browse & Filter**, then press the **Select** button to open the **Browse & Filter** menu.

Browse Programs: Browse programmes in the Guide by their genres.

Filter Channels: Choose if you want to show all channels or just your favourite channels in the guide.

Highlight: Highlight channels with subtitles, audio description or that are signed.

Scrolling Forwards or Backwards Through the Guide Day by Day

When you first enter the Guide you will see what's on Now . If you would like to scroll forward or back a day at a time then press the **Fast Forward** or **Rewind** buttons.

To scroll forward through the Guide a day at a time press the **Fast Forward** button, you will see Tomorrow then the next day and date. To scroll back through the Guide a day at a time press the **Rewind** button you will see Yesterday then the next day and date.

On Screen Mini Guide

While watching a Live TV channel you can view a mini guide which lets you see what's coming up on the current channel or if you scroll across you can also select other channels. The mini guide is a quick way to see what's on without interrupting what you're watching.

When a TV channel is turned on programme information will be displayed. You can also press the **Live** button (availability depends on the model of the remote) to display programme information.

Press the Down directional button twice or press the **Live** button again and the mini guide will appear.

Audio & Subtitles: Set audio and subtitle preference.

Browse & Filter: Opens **Browse & Filter** menu.

Guide: Opens the TV Guide.

Settings: Adjust Audio & Subtitle settings, Red Button Apps (HBBTV) settings and set low signal strength alert preference for broadcasts.

Signal: Shows the signal strength and quality of the channel selected.

Connecting to the Internet

You can access the Internet via your TV, by connecting it to a broadband system. It is necessary to configure the network settings in order to enjoy a variety of streaming content and internet applications. These settings can be configured from **Settings>Network** menu.

Wired Connection

Connect your TV to your modem/router via an Ethernet cable. There is a LAN port on the rear side of your TV. Your TV will automatically connect to the network. If it doesn't, you will need to enable the network connection manually using the **Enable Network** option in the **Network** menu. Highlight this option and press **Select** to enable.

You can check the status of the connection using the **Ethernet Configuration** option in the **Network** menu. Highlight this option and press **Play/Pause** button on the remote to see the network status.

To configure your wired connection settings manually highlight **Ethernet Configuration** and press the **Select** button. Follow the on-screen dialogues to proceed and enter the required values respectively.

If the Ethernet cable is not connected, depending on the current connection status, **Configure Ethernet Connection** or **Configure Network** option will be available instead of **Ethernet Configuration** option.

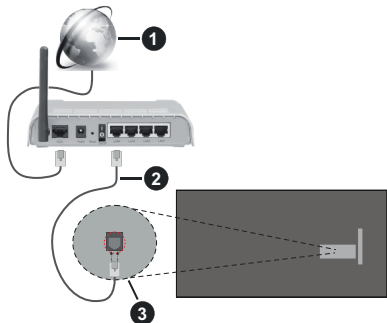

1. Broadband ISP connection
2. LAN (Ethernet) cable
3. LAN input on the rear side of the TV

You might be able to connect your TV to a network wall socket depending on your network's configuration. In that case, you can connect your TV directly to the network using an Ethernet cable.

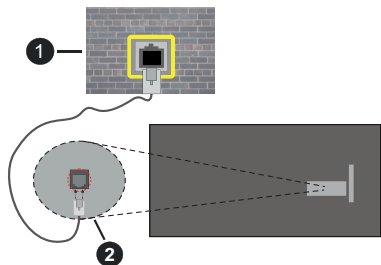

1. Network wall socket
2. LAN input on the rear side of the TV

Wireless Connection

A wireless LAN modem/router is required to connect the TV to the Internet via wireless LAN.

Highlight **Enable Network** option in the **Network** menu and press **Select** to enable wireless connection. Then disconnect the Ethernet cable, if connected priorly. Some of the available networks will be listed. Highlight **See All Networks** and press **Select** to see the complete list.

If you prefer to connect your TV to your network via WLAN you have 3 ways to do this.

- Highlight one of the listed available wireless networks and press **Select**. Then enter the password if the network is password protected.
- Use the WPS button on your router. Highlight **Join Network Using WPS (Button)** option and press **Select**. Press the WPS button on your router. Your TV will connect to your router, without the use of a password.

*Note: During the initial setup process **Connect using WPS Push Button** option will be available instead of **Join Network Using WPS (Button)** option.*

- Enter WPS PIN on your router. Highlight **Join Network Using WPS (PIN)** option and press **Select**. A code will be created and displayed on the screen. Enter this code on your router. Your TV will connect to your router, without the use of a password.

*Note: During the initial setup process **Connect using WPS PIN** option will be available instead of **Join Network Using WPS (PIN)** option.*



1. Broadband ISP connection

A network with hidden SSID can not be detected by other devices. If you want to connect to a network with hidden SSID, highlight the **Join Other Network** option under the **Network** menu and press **Select**. Add the network by entering its name, security type and password manually. If you want to configure additional settings of the network manually, highlight **Advanced** when prompted and press **Select**. Follow the on-screen instructions to proceed and enter the required values respectively.

If you want to save the wireless network passwords to Amazon you can use the **Save Wi-Fi Passwords to Amazon** option. To delete saved passwords turn this option off.

A Wireless-N router (IEEE 802.11a/b/g/n/ac) with 2.4 and 5 GHz bands is designed to increase bandwidth. These are optimised for smoother and faster HD video streaming, file transfers and wireless gaming.

Use a LAN connection for quicker data transfer between other devices like computers.

The transmission speed differs depending on the distance and number of obstructions between the transmission products, the configuration of these products, the radio wave conditions, the line traffic and the products that you use. The transmission may also be cut off or may get disconnected depending on the radio wave conditions, DECT phones or any other WLAN 11b appliances. The standard values of the transmission speed are the theoretical maximum values for the wireless standards. They are not the actual speeds of data transmission.

The location where the transmission is most effective differs depending on the usage environment.

The Wireless feature of the TV supports 802.11 a,b,g,n & ac type modems. It is highly recommended that you should use the IEEE 802.11ac communication protocol in order to avoid any possible problems while watching videos.

You must change your modem's SSID when there are any other modems around with the same SSID. You can encounter connection problems otherwise. Use a wired connection if you experience problems with a wireless connection.

A stable connection speed is required to play back streaming content. Use an Ethernet connection if the wireless LAN speed is unstable.

Specification

Digital Reception	Fully integrated digital terrestrial-cable TV (DVB-T-C) (DVB-T2 compliant)
Channel Indicator	On Screen Display
RF Aerial Input	75 Ohm (unbalanced)
Operating Voltage	220-240V AC, 50Hz.
Audio	DTS HD DTS VIRTUAL:X
Headphone	3.5 mm mini stereo jack
Networked Standby Power Consumption (W)	< 2
Audio Output Power (WRMS.) (10% THD)	2 x 6 W
Power Consumption (W)	60 W
Weight (Kg)	5 Kg
TV Dimensions DxLxH (with foot) (mm)	185 x 728 x 475
TV Dimensions DxLxH (without foot) (mm)	76 x 728 x 431
Display	16/9 32"
Operation temperature and operation humidity	0°C up to 40°C, 85% humidity max

For more product information, please visit
EPREL: <https://eprel.ec.europa.eu>.

EPREL registration number is available on
<https://eprel.panasonic.eu/product>.

Wireless LAN Transmitter Specifications

Frequency Ranges	Max Output Power
2400 - 2483,5 MHz (CH1 - CH13)	< 100 mW
5150 - 5250 MHz (CH36 - CH48)	< 200 mW
5250 - 5350 MHz (CH52 - CH64)	< 200 mW
5470 - 5725 MHz (CH100 - CH140)	< 200 mW

Country Restrictions

The Wireless LAN equipment is intended for home and office use in all EU countries, the UK and Northern Ireland (and other countries following the relevant EU and/or UK directive). The 5.15 - 5.35 GHz band is restricted to indoor operations only in the EU countries, in the UK and Northern Ireland (and other countries following the relevant EU and/or UK directive). Public use is subject to general authorisation by the respective service provider.

Country	Restriction
Russian Federation	Indoor use only

The requirements for any country may change at any time. It's recommended that user checks with local authorities for the current status of their national regulations for both 2.4 GHz and 5 GHz wireless LAN's.

Standard

IEEE 802.11.a/b/g/n

Host Interface

USB 2.0

Security

WEP 64/128, WPA, WPA2, TKIP, AES, WAPI

Notice

DVB / Data broadcasting / IPTV functions

• This TV is designed to meet the standards (as of March, 2021) of DVB-T / T2 (MPEG2, MPEG4-AVC(H.264) and HEVC(H.265)) digital terrestrial services and DVB-C (MPEG2, MPEG4-AVC(H.264) and HEVC(H.265)) digital cable services.

Consult your local dealer for availability of DVB-T / T2 services in your area.

Consult your cable service provider for availability of DVB-C services with this TV.

- This TV may not work correctly with the signal which does not meet the standards of DVB-T / T2 or DVB-C.
 - Not all the features are available depending on the country, area, broadcaster, service provider and network environment.
 - Not all CI modules work properly with this TV. Consult your service provider about the available CI module.
 - This TV may not work correctly with CI module that is not approved by the service provider.
 - Additional fees may be charged depending on the service provider.
 - The compatibility with future services is not guaranteed.
 - Internet apps are provided by their respective service providers, and may be changed, interrupted, or discontinued at any time.
- Panasonic assumes no responsibility and makes no warranty for the availability or the continuity of the services.
- Panasonic does not guarantee operation and performance of peripheral devices made by other manufacturers; and we disclaim any liability or damage arising from operation and/or performance from usage of such other maker's peripheral devices.

Licences

The terms HDMI, HDMI High-Definition Multimedia Interface, HDMI trade dress and the HDMI Logos are trademarks or registered trademarks of HDMI Licensing Administrator, Inc.



Manufactured under licence from Dolby Laboratories. Dolby, Dolby Audio, and the double-D symbol are trademarks of Dolby Laboratories Licensing Corporation.

For DTS patents, see <http://patents.dts.com>.
Manufactured under licence from DTS Licensing

Limited. DTS, DTS-HD, Virtual:X, and the DTS-HD logo are registered trademarks or trademarks of DTS, Inc. in the United States and other countries. © 2022 DTS, Inc. ALL RIGHTS RESERVED.



The *Bluetooth*[®] word mark and logos are registered trademarks owned by the Bluetooth SIG, Inc. and any use of such marks by Vestel Elektronik Sanayi ve Ticaret A.S. is under licence. Other trademarks and trade names are those of their respective owners.

This product contains technology subject to certain intellectual property rights of Microsoft. Use or distribution of this technology outside of this product is prohibited without the appropriate licence(s) from Microsoft.

Content owners use Microsoft PlayReady™ content access technology to protect their intellectual property, including copyrighted content. This device uses PlayReady technology to access PlayReady-protected content and/or WMDRM-protected content. If the device fails to properly enforce restrictions on content usage, content owners may require Microsoft to revoke the device's ability to consume PlayReady-protected content. Revocation should not affect unprotected content or content protected by other content access technologies. Content owners may require you to upgrade PlayReady to access their content. If you decline an upgrade, you will not be able to access content that requires the upgrade.

The "CI Plus" Logo is a trademark of CI Plus LLP.

This product is protected by certain intellectual property rights of Microsoft Corporation. Use or distribution of such technology outside of this product is prohibited without a licence from Microsoft or an authorised Microsoft subsidiary.

Amazon, Alexa, Fire, Prime Video and all related logos are trademarks of Amazon.com, Inc. or its affiliates.



Disposal of Old Equipment and Batteries

Only for European Union and countries with recycling systems



These symbols on the products, packaging, and/or accompanying documents mean that used electrical and electronic products and batteries must not be mixed with general household waste.

For proper treatment, recovery and recycling of old products and batteries, please take them to applicable collection points in accordance with your national legislation.

By disposing of them correctly, you will help to save valuable resources and prevent any potential negative effects on human health and the environment.

For more information about collection and recycling, please contact your local municipality.

Penalties may be applicable for incorrect disposal of this waste, in accordance with national legislation.

Note for the battery symbol (bottom symbol):



This symbol might be used in combination with a chemical symbol. In this case it complies with the requirement set by the Directive for the chemical involved.

Declaration of Conformity (DoC)

Hereby, Panasonic Marketing Europe GmbH, declares that this TV is in compliance with the essential requirements and other relevant provisions of the Directive 2014/53/EU.

If you want to get a copy of the original DoC of this TV, please visit the following website:

<http://www.ptc.panasonic.eu/compliance-documents>

Authorised Representative:

Panasonic Testing Centre

Panasonic Marketing Europe GmbH

Winsbergring 15, 22525 Hamburg, Germany

Web Site: <http://www.panasonic.com>

UK Declaration of Conformity (DoC)

Hereby, Panasonic Marketing Europe GmbH declares that this product is in compliance with the essential requirements and other relevant provisions of the Radio Equipment Regulations 2017 No. 1206.

If you want to get a copy of the original DoC of this product, please visit the following website:

<http://www.ptc.panasonic.eu/compliance-documents>

Panasonic Marketing Europe GmbH, Wiesbaden, Germany

Importer for UK:

Panasonic UK, a branch of Panasonic Marketing Europe GmbH

Maxis 2, Western Road, Bracknell, Berkshire, RG12 1RT

Sales and Support Information

Customer Communication Centre

- For customers within the UK: **0344 844 3899**
- For customers within Ireland: **01289 8333**
- Monday - Friday 9:00am - 5:00pm, (Excluding public holidays).
- For further support on your product, please visit our website: **www.panasonic.co.uk**

Direct Sales at Panasonic UK

- Order accessory and consumable items for your product with ease and confidence by phoning our Customer Communications Centre Monday - Friday 9:00am - 5:00pm, (Excluding public holidays).
- Or go on line through our Internet Accessory ordering application at **www.pas-europe.com**.
- Most major credit and debit cards accepted.
- All enquiries transactions and distribution facilities are provided directly by Panasonic UK.
- It couldn't be simpler!
- Also available through our Internet is direct shopping for a wide range of finished products. Take a browse on our website for further details.

Important Instruction

For your own safety read following instruction carefully before attempting to connect this unit to the mains supply.

MAINS (AC) OPERATION

The wires in the mains lead are coloured in accordance with the following code :

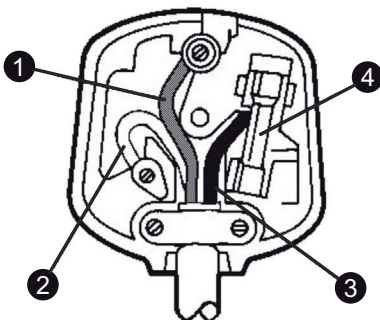

1. Green&Yellow (Earth) (if there is earth cable)
2. Blue (Neutral)
3. Brown (Live)
4. Fuse

IMPORTANT

As the colours of the wires in the mains lead of this appliance may not correspond with the coloured markings identifying the terminals in your plug, proceed as follows:

The wire which is coloured green and yellow must be connected to the terminal which is marked with the letter E, or by the earth symbol, or coloured green or green and yellow.

The wire which is coloured blue or black must be connected to the terminal which is marked with the letter N or coloured Black.

The wire which is coloured brown or red must be connected to the terminal which is marked with the letter L or coloured Red.

For continued protection against risk of fire, replace only with same type and rating of fuse (ASTA approved 5A 250VAC fuse).

CAUTION

TO PREVENT ELECTRIC SHOCK DISCONNECT FROM THE MAINS BEFORE REMOVING COVER. NO USER SERVICEABLE PARTS INSIDE. REFER SERVICING TO QUALIFIED SERVICE PERSONNEL.

SAFETY PRECAUTION

THIS EQUIPMENT MUST BE DISCONNECTED FROM THE MAINS WHEN NOT IN USE. DO NOT ALLOW THIS UNIT TO BE EXPOSED TO RAIN OR MOISTURE.