

# **Panasonic<sup>®</sup>**

## **OPERATING INSTRUCTIONS**

### **TS-32N30AEY**

### **LED TV**

## Contents

Safety Information .....	2
Markings on the Product.....	2
Assembling / Removing the pedestal .....	4
When using the wall-hanging bracket.....	4
Environmental Information.....	5
Features .....	5
Accessories Included.....	5
TV Control & Operation .....	5
Using Main TV Menu .....	6
Inserting the Batteries into the Remote .....	6
Power Connection .....	6
Antenna Connection .....	6
Switching On/Off.....	6
First Time Installation.....	7
Media Playback via USB Input .....	7
Software Upgrade.....	7
Important Instruction.....	8
Specification .....	9
Remote Control .....	10
Troubleshooting & Tips.....	11
Licence Notification .....	11
Disposal of Old Equipment and Batteries.....	11
Declaration of Conformity (DoC) .....	12
UK Declaration of Conformity (DoC) .....	12
Sales and Support Information .....	12
More Information .....	12

## Safety Information

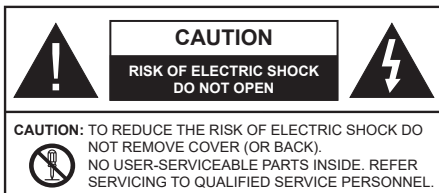

In extreme weather (storms, lightning) and long inactivity periods (going on holiday) disconnect the TV set from the mains.

The mains plug is used to disconnect TV set from the mains and therefore it must remain readily operable. If the TV set is not disconnected electrically from the mains, the device will still draw power for all situations even if the TV is in standby mode or switched off.

**Note:** Follow the on screen instructions for operating the related features.

### IMPORTANT - Please read these instructions fully before installing or operating

**WARNING:** This device is intended to be used by persons (including children) who are capable / experienced of operating such a device unsupervised, unless they have been given supervision or instruction concerning the use of the device by a person responsible for their safety.

- Use this TV set at an altitude of less than 5000 metres above the sea level, in dry locations and in regions with moderate or tropical climates.
- The TV set is intended for household and similar indoor use but may also be used in public places.
- For ventilation purposes, leave at least 5cm of free space around the TV.
- The ventilation should not be impeded by covering or blocking the ventilation openings with items, such as newspapers, table-cloths, curtains, etc.
- The power cord/plug should be easily accessible. Do not place the TV, furniture, etc. on the power cord. A damaged power cord/plug can cause fire or give you an electric shock. Handle the power cord by the plug, do not unplug the TV by pulling the power cord. Never touch the power cord/plug with wet hands as this could cause a short circuit or electric shock. Never make a knot in the power cord or tie it with other cords. When damaged it must be replaced, this should only be done by qualified personnel.
- Do not expose the TV to dripping or splashing of liquids and do not place objects filled with liquids, such as vases, cups, etc. on or over the TV (e.g. on shelves above the TV).

- Do not expose the TV to direct sunlight or do not place open flames such as lit candles on the top of or near the TV.
- Do not place any heat sources such as electric heaters, radiators, etc. near the TV set.
- Do not place the TV on the floor or inclined surfaces.
- To avoid danger of suffocation, keep plastic bags out of the reach of babies, children and domestic animals.
- Carefully attach the stand to the TV. If the stand is provided with screws, tighten the screws firmly to prevent the TV from tilting. Do not over-tighten the screws and mount the stand rubbers properly.
- Do not dispose of the batteries in fire or with hazardous or flammable materials.

### WARNING

- Batteries must not be exposed to excessive heat such as sunshine, fire or the like.
- Excessive sound pressure from earphones or headphones can cause hearing loss.

**ABOVE ALL - NEVER let anyone, especially children, push or hit the screen, push anything into holes, slots or any other openings in the TV.**

Caution	Serious injury or death risk
Risk of electric shock	Dangerous voltage risk
Maintenance	Important maintenance component

### Markings on the Product

The following symbols are used on the product as a marker for restrictions and precautions and safety instructions. Each explanation shall be considered where the product bears related marking only. Note such information for security reasons.



**Class II Equipment:** This appliance is designed in such a way that it does not require a safety connection to electrical earth.



**Hazardous Live Terminal:** The marked terminal(s) is/are hazardous live under normal operating conditions.



**Caution, See Operating Instructions:** The marked area(s) contain(s) user replaceable coin or button cell batteries.



**Class 1 Laser Product:** This product contains Class 1 laser source that is safe under reasonably foreseeable conditions of operation.

## WARNING

Do not ingest the battery, Chemical Burn Hazard  
This product or the accessories supplied with the product may contain a coin/button cell battery. If the coin/button cell battery is swallowed, it can cause severe internal burns in just 2 hours and can lead to death. Keep new and used batteries away from children. If the battery compartment does not close securely, stop using the product and keep it away from children. If you think batteries might have been swallowed or placed inside any part of the body, seek immediate medical attention.

-----

### Warning Stability Hazard

A television may fall, causing serious personal injury or death. Many injuries, particularly to children, can be avoided by taking simple precautions such as:

- ALWAYS use cabinets or stands or mounting methods recommended by the manufacturer of the television set.
- ALWAYS use furniture that can safely support the television set.
- ALWAYS ensure the television set is not overhanging the edge of the supporting furniture.
- ALWAYS educate children about the dangers of climbing on furniture to reach the television set or its controls.
- ALWAYS route cords and cables connected to your television so they cannot be tripped over, pulled or grabbed.
- NEVER place a television set in an unstable location.
- NEVER place the television set on tall furniture (for example, cupboards or bookcases) without anchoring both the furniture and the television set to a suitable support.
- NEVER place the television set on cloth or other materials that may be located between the television set and supporting furniture.
- NEVER place items that might tempt children to climb, such as toys and remote controls, on the top of the television or furniture on which the television is placed.
- The equipment is only suitable for mounting at heights  $\leq 2$  m.

If the existing television set is going to be retained and relocated, the same considerations as above should be applied.

-----

Apparatus connected to the protective earthing of the building installation through the MAINS connection or through other apparatus with a connection to protective earthing – and to a television distribution system using coaxial cable, may in some circumstances create a fire hazard. Connection to a television distribution system has therefore to be provided through a device providing electrical isolation below a certain frequency range (galvanic isolator).

## WALL MOUNTING WARNINGS

- Read the instructions before mounting your TV on the wall.
- The wall mount kit is optional. You can obtain from your local dealer, if not supplied with your TV.
- Do not install the TV on a ceiling or on an inclined wall.
- Use the specified wall mounting screws and other accessories.
- Tighten the wall mounting screws firmly to prevent the TV from falling. Do not over-tighten the screws.

### WARNING

- Using other wall-hanging brackets, or installing a wall-hanging bracket by yourself have the risk of personal injury and product damage. In order to maintain the unit's performance and safety, be absolutely sure to ask your dealer or a licensed contractor to secure the wall-hanging brackets. Any damage caused by installing without a qualified installer will void your warranty.
- Carefully read the instructions accompanying optional accessories, and be absolutely sure to take steps to prevent the TV from falling off.
- Handle the TV carefully during installation since subjecting it to impact or other forces may cause product damage.
- Take care when fixing wall brackets to the wall. Always ensure that there are no electrical cables or pipes in the wall before hanging bracket.
- To prevent fall and injury, remove the TV from its fixed wall position when it is no longer in use.

### DAMAGES

- Excepting cases where responsibility is recognised by local regulations, Panasonic accepts no responsibility for malfunctions caused by misuse or use of the product, and other problems or damages caused by use of this product.
- Panasonic accepts no responsibility for loss, etc., of data caused by disasters.
- External devices separately prepared by the customer are not covered by the warranty. Care for the data stored in such devices is the responsibility of the customer. Panasonic accepts no responsibility for abuse of this data.

Figures and illustrations in these operating instructions are provided for reference only and may differ from the actual product appearance. Product design and specifications may be changed without notice.

## Assembling / Removing the pedestal

### Preparations

Take out the pedestal(s) and the TV from the packing case and put the TV onto a work table with the screen panel down on the clean and soft cloth (blanket, etc.)

- Use a flat and firm table bigger than the TV.
- Do not hold the screen panel part.
- Make sure not to scratch or break the TV.

### Assembling the pedestal

1. The stand of the TV consists of two pieces. Install these pieces together.

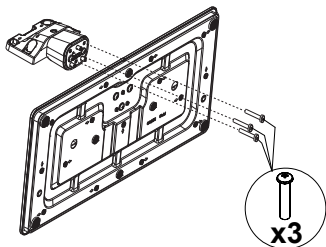

2. Place the stand(s) on the stand mounting pattern(s) on the rear side of the TV.

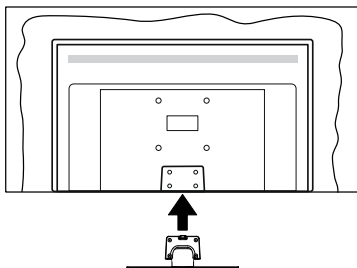

3. Insert the screws (M4 x 12 mm) provided and tighten them gently until the stand is properly fitted.

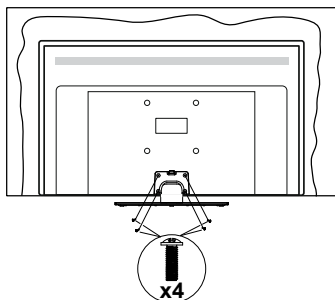

## Removing the pedestal from the TV

Be sure to remove the pedestal in the following way when using the wall-hanging bracket or repacking the TV.

- Put the TV onto a work table with the screen panel down on the clean and soft cloth. Leave the stand(s) protruding over the edge of the surface.
- Unscrew the screws that fixing the stand(s).
- Remove the stand(s).

### When using the wall-hanging bracket

Please contact your local Panasonic dealer to purchase the recommended wall-hanging bracket.

Holes for wall-hanging bracket installation;

### Rear of the TV

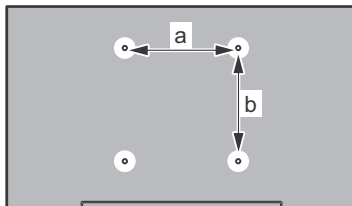

a (mm)	75
b (mm)	75

### View from the side

VESA  
Bracket

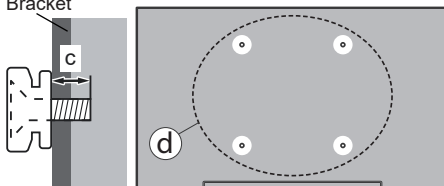

(d)	Depth of screw (c)	min.	9 mm
		max.	10 mm
	Diameter		M4

**Note:** The screws for fixing the TV onto the wall-hanging bracket are not supplied with the TV.

## Environmental Information

This television is designed to be environment friendly. To reduce energy consumption, you can follow these steps:

If you set the **Energy Saving** to **Minimum**, **Medium**, **Maximum** or **Auto** the TV will reduce the energy consumption accordingly. If you like to set the **Backlight** to a fixed value set as **Custom** and adjust the **Backlight** (located under the **Energy Saving** setting) manually using Left or Right buttons on the remote. Set as **Off** to turn this setting off.

*Note: Available **Energy Saving** options may differ depending on the selected **Mode** in the **Picture** menu.*

The **Energy Saving** settings can be found in the **Picture** menu. Note that some picture settings will be unavailable to be changed.

If pressed **Right** button while **Auto** option is selected or **Left** button while **Custom** option is selected, "**Screen will be off in 15 seconds.**" message will be displayed on the screen. Select **Proceed** and press **OK** to turn the screen off immediately. If you don't press any button, the screen will be off in 15 seconds. Press any button on the remote or on the TV to turn the screen on again.

*Note: **Screen Off** option is not available if the **Mode** is set to **Game**.*

When the TV is not in use, please switch off or disconnect the TV from the mains plug. This will also reduce energy consumption.

## Features

- Remote controlled colour TV
- Fully integrated digital terrestrial/cable/satellite TV (DVB-T-T2/C/S-S2)
- HDMI inputs to connect other devices with HDMI sockets
- USB input
- OSD menu system
- Scart socket for external devices (such as DVD Players, PVR, video games, etc.)
- Stereo sound system
- Teletext
- Headphone connection
- Automatic programming system
- Manual tuning
- Automatic power down after up to eight hours
- Sleep timer
- Child lock
- Automatic sound mute when no transmission
- NTSC playback
- AVL (Automatic Volume Limiting)
- PLL (Frequency Search)
- PC input
- Game Mode (Optional)
- Picture off function

## Accessories Included

- Remote Control
- Batteries: 2 x AA
- Quick Start Guide
- Power Cord
- Detachable stand
- Stand mounting screws (M4 x 12 mm)

## TV Control & Operation

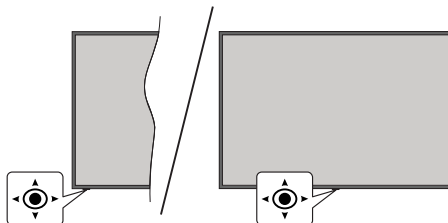

The joystick allows you to control the Volume / Programme / Source and Standby-On functions of the TV.

*Note: The position of the joystick may differ depending on the model.*

## Using Main TV Menu

When the **Home** button is pressed, the main TV menu will appear on the screen. You can navigate through the menu items using the directional buttons on the remote. To select an item or see the sub-menu options of the highlighted menu press **OK** button. Press **Exit** button to close the main menu.

## Inserting the Batteries into the Remote

Remove the back cover to reveal the battery compartment. Insert two size **AA** batteries. Make sure the (+) and (-) signs match (observe correct polarity). Do not mix old and new batteries. Replace only with same or equivalent type. Place the cover back on.

Batteries should not be exposed to excessive heat such as sunshine, fire or the like.

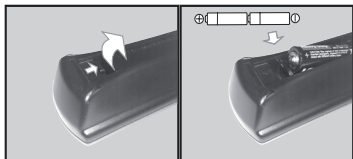

## Power Connection

**IMPORTANT:** The TV set is designed to operate on a **220-240V AC, 50 Hz** supply. After unpacking, allow the TV set to reach the ambient room temperature before you connect the set to the mains.

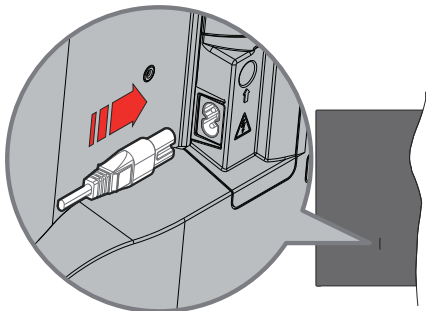

Plug one end (the two-hole plug) of the supplied detachable power cord into the power cord inlet on the rear side of the TV as shown above. Then plug the other end of the power cord into the mains socket outlet.

**Note:** The position of the power cord inlet may differ depending on the model.

## Antenna Connection

Connect the aerial or cable TV plug to the **AERIAL INPUT (ANT.)** socket or satellite plug to the **SATELLITE INPUT (LNB)** socket located on the rear side of the TV.

### Rear side of the TV

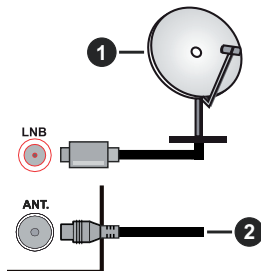

1. Satellite
2. Aerial or cable



If you want to connect a device to the TV, make sure that both the TV and the device are turned off before making any connection. After the connection is done, you can turn on the units and use them.

## Switching On/Off

### To Switch the TV On

Connect the power cord to a power source such as a wall socket (220-240V AC, 50 Hz).

To switch on the TV from standby mode either:

- Press the **Standby** button, **Programme +/-** or a numeric button on the remote control.
- Press the centre of the joystick on the TV in or push it up/down.

### To Switch the TV Off

Press the **Standby** button on the remote control or press the centre of the joystick on the TV in and hold it down for a few seconds, the TV will switch into standby mode.

**To power down the TV completely, unplug the power cord from the mains socket.**

**Note:** When the TV is switched into standby mode, the standby LED can blink to indicate that features such as Standby Mode Search, Over Air Download or Timer is active. The LED can also blink when you switch on the TV from standby mode.

## First Time Installation

When turned on for the first time, the language selection screen is displayed. Select the desired language and press **OK**. In the following steps of the installation, set your preferences using the directional buttons and **OK** button. The installation wizard will guide you through the setup process. You can perform first time installation anytime using the option in the **Setup** menu.

## Media Playback via USB Input

*You can connect 2.5" and 3.5" inch (HDD with external power supply) external hard disk drives or USB memory stick to your TV by using the USB inputs of the TV.*

**IMPORTANT!** Back up the files on your storage devices before connecting them to the TV. Manufacturer will not be responsible for any file damage or data loss. Certain types of USB devices (e.g. MP3 Players) or USB hard disk drives/memory sticks may not be compatible with this TV. The TV supports FAT32 and NTFS disk formatting.

Wait a little while before each plugging and unplugging as the player may still be reading files. Failure to do so may cause physical damage to the USB player and the USB device itself. Do not pull out your drive while playing a file.

You can use USB hubs with your TV's USB inputs. External power supplied USB hubs are recommended in such a case.

It is recommended to use the TV's USB input(s) directly, if you are going to connect a USB hard disk.

**Note:** When viewing image files the **Media Player** menu can only display 1000 image files stored on the connected USB device.

## Software Upgrade

Your TV is capable of finding and updating the firmware automatically via the broadcast signal.

### Software upgrade search via user interface

On the main menu select **Setup** and press the **OK** button. **Setup Menu will be displayed.** Then select **More** and press the **OK** button. Navigate to **Software upgrade** and press the **OK** button. In **Upgrade options** menu select **Scan for upgrade** and press **OK** button to check for a new software upgrade.

If a new upgrade is found, it starts to download the upgrade. After the download is completed confirm the question asking about rebooting the TV by pressing the **OK** to continue with the reboot operation.

### 3 AM search and upgrade mode

Your TV will search for new upgrades at 3:00 o'clock if **Automatic scanning** option in the **Upgrade options** menu is set to **Enabled** and if the TV is connected to an aerial signal. If a new software is found and downloaded successfully, it will be installed at the next power on.

**Note:** Do not unplug the power cord while led is blinking during the reboot process. If the TV fails to come on after the upgrade, unplug, wait for two minutes then plug it back in.



## Important Instruction

For your own safety read following instruction carefully before attempting to connect this unit to the mains supply.

### MAINS (AC) OPERATION

The wires in the mains lead are coloured in accordance with the following code :

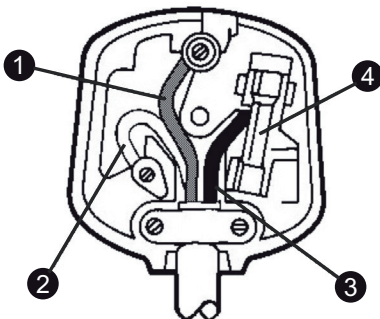

1. Green&Yellow (Earth) (if there is earth cable)
2. Blue (Neutral)
3. Brown (Live)
4. Fuse

### IMPORTANT

As the colours of the wires in the mains lead of this appliance may not correspond with the coloured markings identifying the terminals in your plug, proceed as follows:

The wire which is coloured green and yellow must be connected to the terminal which is marked with the letter E, or by the earth symbol, or coloured green or green and yellow.

The wire which is coloured blue or black must be connected to the terminal which is marked with the letter N or coloured Black.

The wire which is coloured brown or red must be connected to the terminal which is marked with the letter L or coloured Red.

For continued protection against risk of fire, replace only with same type and rating of fuse (ASTA approved 5A 250VAC fuse).

### CAUTION

TO PREVENT ELECTRIC SHOCK DISCONNECT FROM THE MAINS BEFORE REMOVING COVER. NO USER SERVICEABLE PARTS INSIDE. REFER SERVICING TO QUALIFIED SERVICE PERSONNEL.

### SAFETY PRECAUTION

THIS EQUIPMENT MUST BE DISCONNECTED FROM THE MAINS WHEN NOT IN USE. DO NOT ALLOW THIS UNIT TO BE EXPOSED TO RAIN OR MOISTURE.

**Specification**

<b>TV Broadcasting</b>	PAL BG//DK SECAM BG/DK
<b>Receiving Channels</b>	VHF (BAND I/III) - UHF (BAND U) - HYPERBAND
<b>Digital Reception</b>	Fully integrated digital terrestrial-cable-satellite TV (DVB-T-C-S) (DVB-T2, DVB-S2 compliant)
<b>Number of Preset Channels</b>	8 000
<b>Channel Indicator</b>	On Screen Display
<b>RF Aerial Input</b>	75 Ohm (unbalanced)
<b>Operating Voltage</b>	220-240V AC, 50Hz.
<b>Audio</b>	A2 Stereo+Nicam Stereo
<b>Headphone</b>	3.5 mm mini stereo jack
<b>Audio Output Power (WRMS.) (10% THD)</b>	2 x 6 W
<b>Power Consumption (W)</b>	60 W
<b>Weight (kg)</b>	5 Kg
<b>TV Dimensions DxLxH (with stand) (mm)</b>	185 x 728 x 475
<b>TV Dimensions DxLxH (without stand) (mm)</b>	76 x 728 x 431
<b>Display</b>	16/9 32"
<b>Operation temperature and operation humidity</b>	0°C up to 40°C, 85% humidity max

For more product information, please visit EPREL:  
<https://eprel.ec.europa.eu>.

EPREL registration number is available on  
<https://eprel.panasonic.eu/product>.

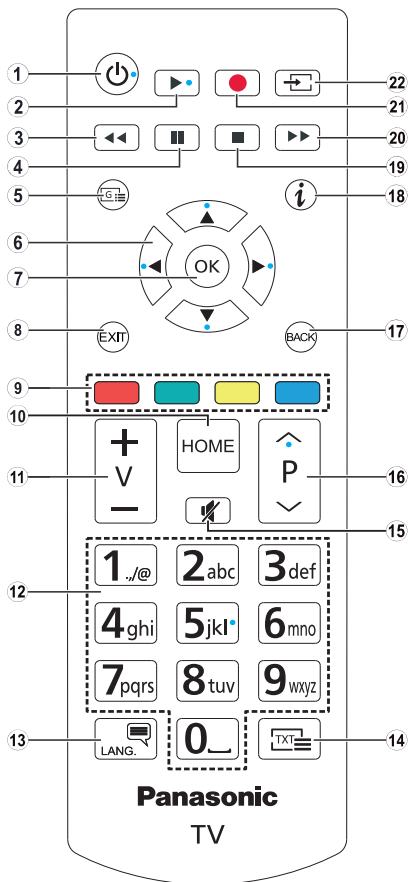

1. **Standby:** Switches On / Off the TV
2. **Play:** Starts to play selected media
3. **Rewind:** Moves frames backwards in media such as movies
4. **Pause:** Pauses the media being played
5. **Guide:** Displays the electronic programme guide
6. **Directional buttons:** Helps navigate menus, content etc. and displays the subpages in TXT mode when pressed Right or Left  
**In media player mode:**  
**Left:** Rapid reverse  
**Right:** Rapid advance
7. **OK:** Confirms user selections, holds the page (in TXT mode), views channel list (DTV mode), Pause (in media player mode)
8. **Exit:** Closes and exits from displayed menus or returns to previous screen
9. **Coloured Buttons:** Follow the on-screen instructions for coloured button functions  
**In media player mode:**  
**Red:** Stop / Play  
**Green:** Play / Jump  
**Yellow:** Pause / Subtitle time correction  
**Blue:** Stop
10. **Home:** Displays TV menu
11. **Volume +/-**
12. **Numeric buttons:** Switches the channel, enters a number or a letter in the text box on the screen, switches the TV on when in standby mode
13. **Language:** Switches among sound modes (analogue TV), displays and changes audio/subtitle language (digital TV, where available)
14. **Text:** Displays teletext (where available), press again to superimpose the teletext over a normal broadcast picture (mix)
15. **Mute:** Completely turns off the volume of the TV
16. **Programme +/-:** Programme up-down, Page up-down (in TXT mode), switches the TV on when in standby mode
17. **Back/Return:** Returns to previous screen, previous menu, opens index page (in TXT mode)
18. **Info:** Displays information about on-screen content, shows hidden information (reveal - in TXT mode)
19. **Stop:** Stops the media being played
20. **Fast Forward:** Moves frames forward in media such as movies
21. No function
22. **Source:** Shows available broadcast and content sources

## Troubleshooting & Tips

### TV will not turn on

Make sure the power cord is plugged in securely to a wall outlet. Press the Power button on the TV.

### Poor picture

- Check if you have correctly tuned the TV.
- Low signal level can cause picture distortion. Please check antenna connections.
- Check if you have entered the correct channel frequency if you have performed manual tuning.

### No picture

- TV is not receiving any signal. Make sure the correct source has been selected.
- Is the antenna connected properly?
- Is the antenna cable damaged?
- Are suitable plugs used to connect the antenna?
- If you are in doubt, consult your dealer.

### No sound

- Check if the TV sound is muted. Press the **Mute** button or increase the volume to check.
- Sound may be coming from only one speaker. Check the balance settings from Sound menu.

### Remote control - no operation

- The batteries may be exhausted. Replace the batteries.
- The batteries maybe inserted incorrectly. Refer to the section "Inserting the Batteries into the Remote".

### No signal on an input source

- It is possible that no device is connected.
- Check the AV cables and connections from your device.
- Check the device is switched on.

## Licence Notification

The terms HDMI, HDMI High-Definition Multimedia Interface, HDMI trade dress and the HDMI Logos are trademarks or registered trademarks of HDMI Licensing Administrator, Inc.



Manufactured under licence from Dolby Laboratories. Dolby, Dolby Audio, and the double-D symbol are trademarks of Dolby Laboratories Licensing Corporation.



The "CI Plus" Logo is a trademark of CI Plus LLP.



## Disposal of Old Equipment and Batteries



### Only for European Union and countries with recycling systems

These symbols on the products, packaging, and/or accompanying documents mean that used electrical and electronic products and batteries must not be mixed with general household waste.

For proper treatment, recovery and recycling of old products and batteries, please take them to applicable collection points in accordance with your national legislation.

By disposing of them correctly, you will help to save valuable resources and prevent any potential negative effects on human health and the environment.

For more information about collection and recycling, please contact your local municipality.

Penalties may be applicable for incorrect disposal of this waste, in accordance with national legislation.

### Note for the battery symbol (bottom symbol):



This symbol might be used in combination with a chemical symbol. In this case it complies with the requirement set by the Directive for the chemical involved.

## Declaration of Conformity (DoC)

Hereby, Panasonic Marketing Europe GmbH, declares that this TV is in compliance with the essential requirements and other relevant provisions of the Directive 2014/53/EU.

If you want to get a copy of the original DoC of this TV, please visit the following website:

<http://www.ptc.panasonic.eu/compliance-documents>

Authorised Representative:

Panasonic Testing Centre

Panasonic Marketing Europe GmbH

Winsbergring 15, 22525 Hamburg, Germany

Web Site: <http://www.panasonic.com>

## UK Declaration of Conformity (DoC)

Hereby, Panasonic Marketing Europe GmbH, declares that this product is in compliance with the essential requirements and other relevant provisions of the Radio Equipment Regulations 2017 No. 1206.

If you want to get a copy of the original DoC of this product, please visit the following website:

<http://www.ptc.panasonic.eu/compliance-documents>

Panasonic Marketing Europe GmbH, Wiesbaden, Germany

Importer for UK:

Panasonic UK, a branch of Panasonic Marketing Europe GmbH

Maxis 2, Western Road, Bracknell, Berkshire, RG12 1RT

## Sales and Support Information

### Customer Communication Centre

- For customers within the UK: **0344 844 3899**
- For customers within Ireland: **01289 8333**
- Monday - Friday 9:00am - 5:00pm, (Excluding public holidays).
- For further support on your product, please visit our website: **[www.panasonic.co.uk](http://www.panasonic.co.uk)**

### Direct Sales at Panasonic UK

- Order accessory and consumable items for your product with ease and confidence by phoning our Customer Communications Centre Monday - Friday 9:00am - 5:00pm, (Excluding public holidays).
- Or go on line through our Internet Accessory ordering application at **[www.pas-europe.com](http://www.pas-europe.com)**.
- Most major credit and debit cards accepted.
- All enquiries transactions and distribution facilities are provided directly by Panasonic UK.
- It couldn't be simpler!
- Also available through our Internet is direct shopping for a wide range of finished products. Take a browse on our website for further details.

## More Information

For more information, please visit the Support page on Panasonic website, where you can find the full manual instruction.

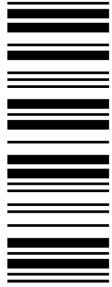

50719849