

# LINEA **R**ESPONSE

INVISIBLE SPEAKERS & SUBWOOFERS

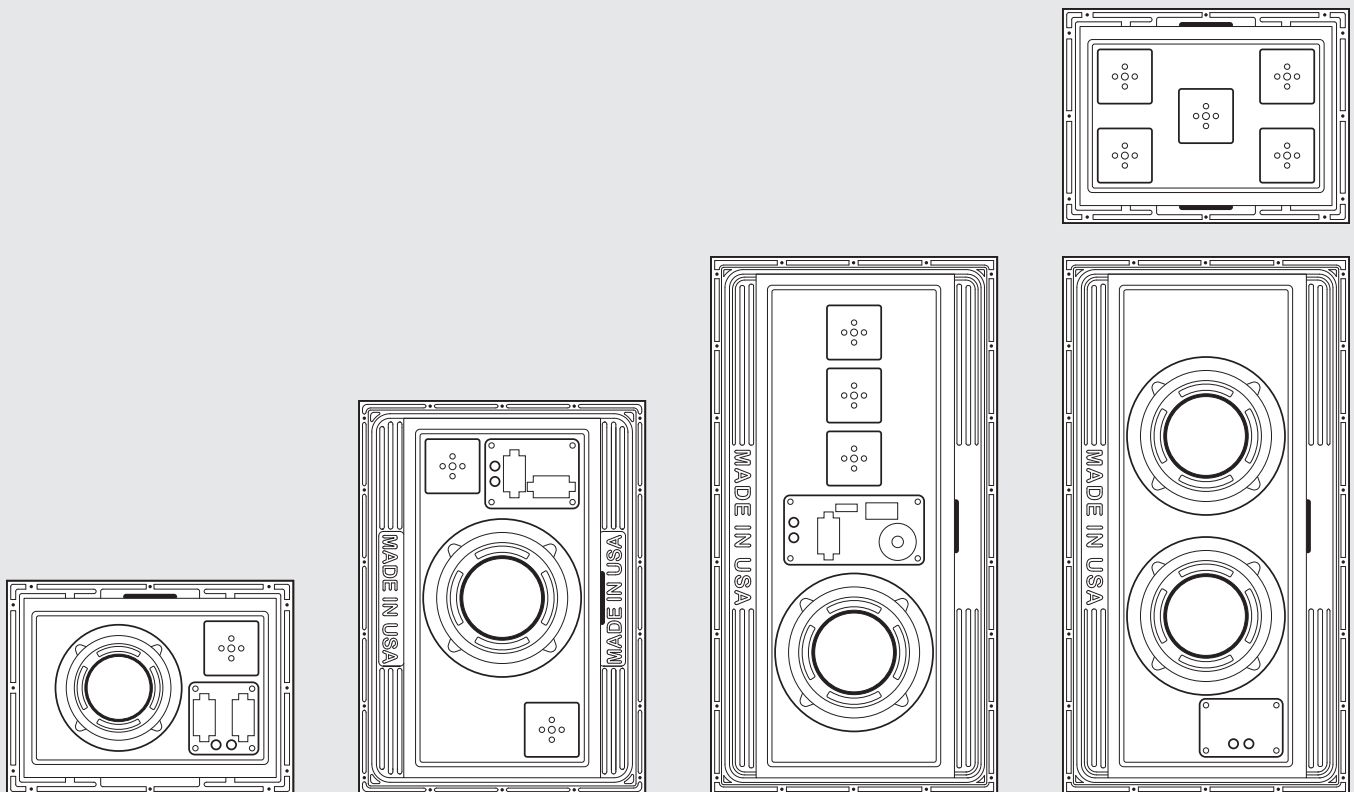

## Quick Start Installation Guide

► For New Construction and Retrofit Installations



## STEALTH ACOUSTICS

Full instructions, installation videos, tips, troubleshooting, and more available at:

[StealthAcoustics.com/invisible-speakers/how-to-install](https://StealthAcoustics.com/invisible-speakers/how-to-install)

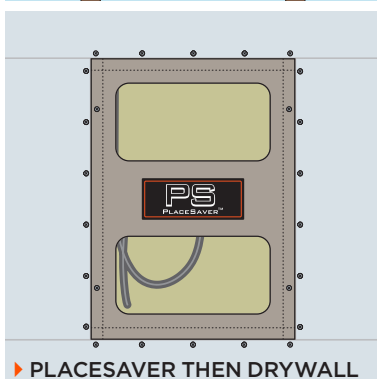
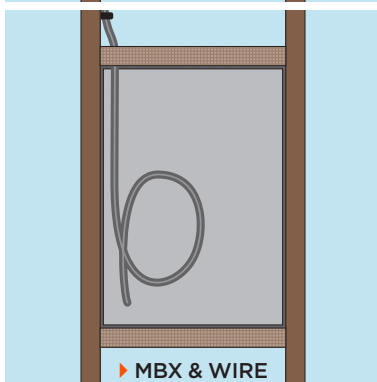
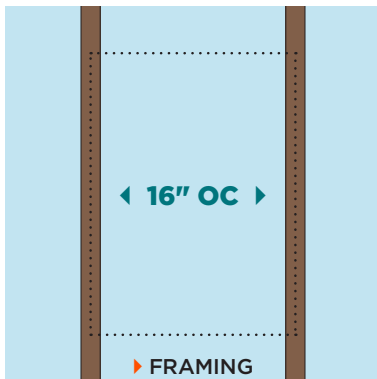
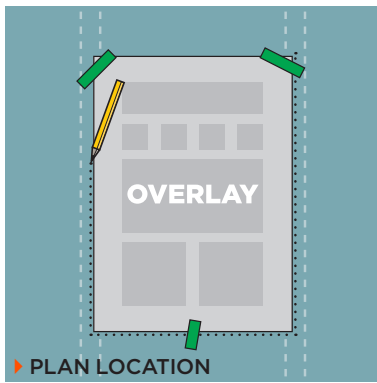

## ▶ RETROFIT INSTALLATION

- ▶ Installing a Stealth Acoustics Invisible Speaker into an already finished wall is similar to making a wallboard patch.
- ▶ Remove the overlay sheets that comes attached to the face of each speaker and temporarily attach them to the walls to assist in planning speaker placement.
- ▶ Once the approximate speaker locations have been selected, use a stud finder to locate the nearest framing cavity and drill test holes to verify. Align the sides of the overlay sheet so they are centered over the existing framing members and use the overlay as a template to cut the wallboard to the size of the speaker. The finished opening should be 16" width centered on the framing studs.

## ▶ SPEAKER INSTALLATION

### 1. FRAMING, BACK BOXES AND PLACESAVERS™

- ▶ For retrofit and for new construction, it is recommended to add cross member framing above and below the speaker opening so that the speaker may be attached on all four sides.
- ▶ Back boxes are recommended. MBA and MBX back boxes should be installed flush with the framing. See the instructions with MBC back boxes for proper installation. BX back boxes are installed at the same time as the speaker panel and instructions are covered below.
- ▶ In new construction, PlaceSavers™ are installed when the job is pre-wired. Center the PlaceSaver™ on the framing and attach with provided hardware. This reserves the exact space for the speaker during the wallboard installation preventing the speaker panel itself from exposure the harsh construction environment. Using PlaceSavers™ will save you time and money.

### 2. WIRING

- ▶ Install regular speaker wiring and attach it securely to the studs. Be sure to feed the wire through the knockout hole in the back box. It is recommended to use a wire clamp to secure the wire at the knockout leaving sufficient slack length to be able to connect to the speaker panel when installed.
- ▶ For runs of 50 feet (15m) or less, use 16 gauge wire.
- ▶ For runs longer than 50 feet (15m), use 14 gauge wire.

### 3. BX BACK BOXES

- ▶ BX Back Boxes install directly onto the Invisible Speaker frame before the speaker frame is installed into the wall. First, insert the back box speaker wires into the binding posts on the speaker crossover, noting proper polarity and then install the box directly to the back of the speaker panel using the provided screws in the pre-drilled holes.

- ▶ **Use only the provided screws as other screws may cause damage to the speaker.**

### 4. SPEAKER ALIGNMENT AND TEST FIT

- ▶ After the wallboard has been installed, remove the PlaceSaver™.
- ▶ Correct registration is achieved when the perimeter screw flange of the speaker is flush with the adjoining wallboard allowing the face of the speaker to protrude approximately 1/16" (2mm) beyond the wallboard. This creates a recess for the seam tape which prevents sanding back into the tape during the finishing process.
- ▶ If necessary, shim the screw flange out flush with the wallboard by layering the provided self-adhesive shims around the perimeter of the rear of the speaker (shims should cover the screw holes).

- ▶ **It is critical to add the correct number of shims so that the wallboard and flange surfaces are flush with one another. If the speaker is recessed in relation to the wallboard excessive material build-up on the surface of the speaker can occur during the finishing process which may lead to poor sound quality and possible premature failure.**

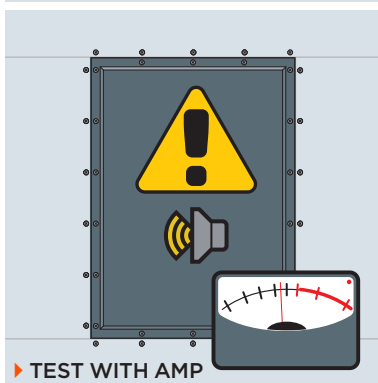
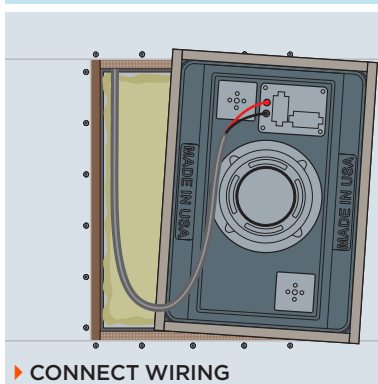
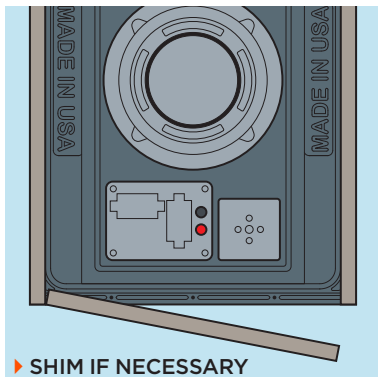
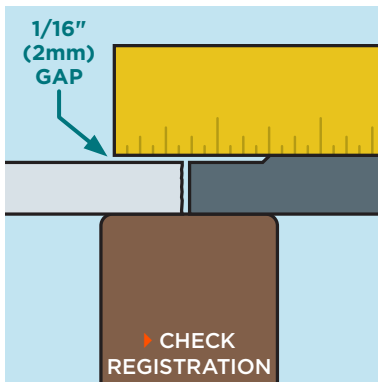

## 5. CONNECT SPEAKER WIRES

- ▶ Insert the speaker wires into the binding posts on the speaker crossover (or BX back box) noting proper polarity.
- ▶ For smaller gauge wires, bend the exposed wire back upon itself prior to insertion to make better contact with the binding posts.

## 6. SPEAKER MOUNTING

- ▶ Attach the speaker panel screw flanges directly to the structural framing using the provided wallboard screws. The panels have been pre-drilled with the proper number of holes. Be sure that all of the screws are installed and that they hold securely to the framing.



- ▶ **Do not use nails.**

## 7. RECHECK SPEAKER REGISTRATION

- ▶ Now that the speaker is secured, recheck that the outer flange of the speaker is flush with the surrounding wallboard.
- ▶ Place a 4-foot straight edge across middle of the speaker to verify that the speaker face protrudes approximately 1/16" (2mm) beyond the wallboard in each direction.



- ▶ **Check that the speaker is not warped from strain caused by uneven framing. A warped speaker frame will cause the speaker face to bulge.**

- ▶ Having the correct registration minimizes the amount of joint compound that might be built up over the face of the speaker during the finishing process. This 1/16" (2mm) protrusion of the speaker face will become invisible after the seams are properly finished and joint compound is feathered out from the speaker appropriately.

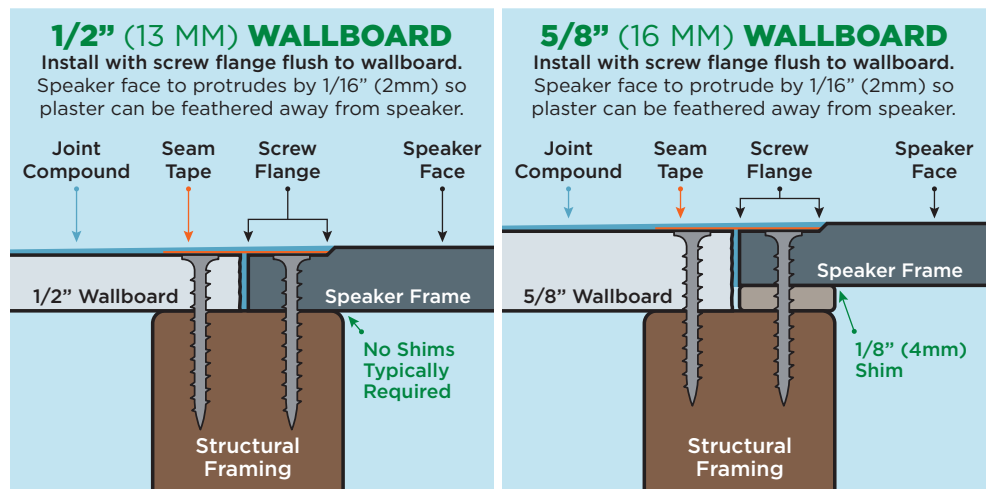

**Note:** The typical installations shown above are provided as guidelines. For your installation, the number and thickness of shims needed may differ due to variances in wallboard material and other construction variables.

## 8. TEST SPEAKER SOUND



- ▶ **Before proceeding to wall finishing, test each speaker with music or pink noise from an amplified sound source at listening volume to ensure full speaker functionality.**

- ▶ Make note of sound coming from the high/mid/low frequency drivers of each speaker and listen for any rattling or vibration.

- ▶ **Now is the time to correct any potential issues.**

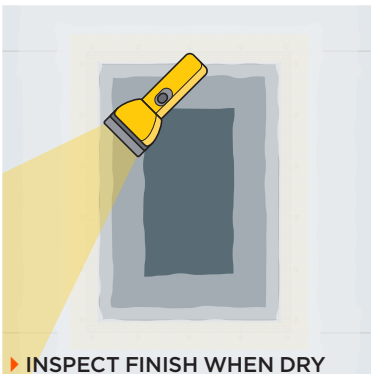
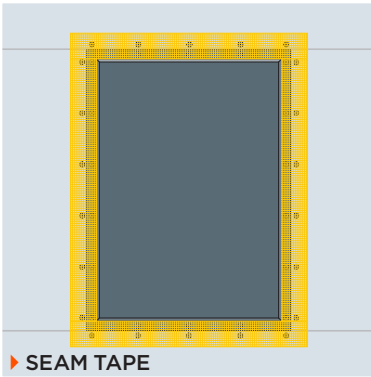

## ▶ WALL FINISHING

### 9. SEAM FINISHING

- ▶ After the registration and sound check, seam finishing can proceed. The speaker panel should be finished in place similar to any other piece of wallboard.
- ▶ Self-adhesive nylon mesh tape is recommended due to its ease of use, however paper tape is also acceptable.
- ⚠ ▶ **Use only air-dry joint compounds and plasters for seam finishing. Do not use chemically curing joint compound.**
- ▶ For best results, we recommend at least three light applications of joint compound, sanding between coats.
- ⚠ ▶ **Allow 24 hours between each application of joint compound for complete drying. Failure to allow the joint compound to completely dry between applications may result in fine hairline cracking around the speaker. If this occurs, repair the crack using standard wall finishing techniques. The crack will not reappear.**
- ▶ The joint compound should be spread beginning 2"-3" in from the speaker edge and then feathering outward 16"-20" in order to achieve a smooth, flat transition.
- ▶ It is important that enough joint compound be applied around the speaker to make a very gradual transition from the surface of the wallboard to the face of the speaker panel. Every situation is different, but it will normally take at least a 16"-20" (30cm) fan of joint compound around the perimeter of the panel to create a flat-looking transition.
- ▶ Be sure to feather the joint compound away from the speaker as to not build up more than the maximum allowed 1/16" (2 mm) of joint compound over the face of the speaker panel.
- ▶ Stealth Acoustics speakers do not require a skim coat to attain a smooth finish. However, some advanced finishing techniques and materials such as Venetian plaster or heavy plaster coats may require skimming over the front of the speaker. In these situations, it may be necessary to shim the speaker proud of the surrounding wallboard so that we avoid build-up of more than 1/16" (2 mm) in thickness on the face of the speaker.

### 10. SAND SMOOTH

- ▶ Sanding is the last important step before the painting begins. This can make or break the quality of the installation.
- ▶ When sanding, imperfections in the application of the joint compound may appear. If so, additional joint compound and sanding may be needed to create a seamless transition.
- ▶ Best practice may include the use of a flashlight to shine sheer light down the wall or ceiling in order to identify high/low spots in the finish work.

### 11. PAINT AND FINISH

- ▶ Once sanding is complete the face panel is ready for painting.
- ▶ Light "orange peel" texture, light knock-down texture, wallpaper, veneer, or level 5 finish may be applied.
- ⚠ ▶ **Heavy knock down or trowel finishes are not recommended. Stealth Acoustics speaker face panels are engineered for optimum audio performance with no more than 1/16" (2mm) of any material applied to the surface of the speaker. To exceed the 1/16" (2mm) limitation will cause degradation of audio quality.**



**StealthAcoustics.com**

**T 888.865.6800 | F 360.424.8872**

**A Division of Dimensional Communications, Inc.**  
1220 Anderson Road | Mount Vernon, WA 98274